

LUBRICATION

- BG type contains a lithium soap based grease. (Multemp PS No.2, KYODO YUSHI) Apply similar type of grease for the lubrication as required depending on the operating conditions.
- Use the grease fitting to lubricate the slide block. For ball screw portion apply grease directly to the surface of screw shaft.
※BG15 slide block has $\phi 2\text{mm}$ oil holes instead of grease fitting.
- Unless otherwise instructed, a grease fitting is located as shown in Figure H-18.
- The grease can be changed to a high function type by adding a special grease option at the end of the part number. Please refer to Table H-15 for the grease type. Also refer to page Eng-39 for further details.

Figure H-18 Location of Grease Fitting

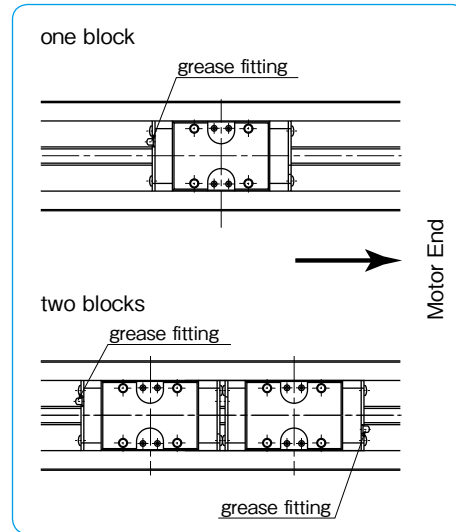

Table H-15 Applicable Grease

grease option	features	product name
none (standard)	—	Multemp PS No.2 (KYODO YUSHI)
GK	urea-type low dust generation grease	K Grease
GU	urea-type low dust generation grease; low sliding resistance	KGU Grease
GL	lithium-type low dust generation grease	KGL Grease
GF	urea-type anti-fretting grease	KGF Grease

OPERATING TEMPERATURE

- Resin parts are incorporated in the BG type. Please avoid using BG type above 80°C. Please use the product at 55°C or lower when sensor/bellows are optioned.

USE AND HANDLING PRECAUTIONS

- Please handle as a precision component and avoid excessive vibration or shock.
- Rough handling will affect the smooth motion and reduce the precision performance and life time.
- DO NOT DISASSEMBLE. The accuracy of BG type is preadjusted when assembled.
- Please allow for extra stroke length. If the guide block repeatedly collides with damper, it may cause damage.
- Please never touch the area at both stroke ends during operation. There is a danger for the fingers to be caught at the stroke end. Please pay enough attention to the guide rail area even when not in operation, there is a danger for the fingers to be injured by the dust cover.
- Depending upon the operating environment, dust and foreign particles may contaminate BG type and disrupt the ball circulation and precision performance.

SLIDE SCREW

SLIDE SCREW

STRUCTURE AND ADVANTAGESI-2
 SIZE SELECTIONI-3
 INSTALLATIONI-6
 USE AND HANDLING PRECAUTIONS I-6
 SPECIAL REQUIREMENTSI-6
 DIMENSION TABLEI-7

SLIDE SCREW

The NB slide screw converts rotational motion into linear motion by utilizing the friction between radial ball bearings and a shaft. This simple mechanism eases maintenance and installation work. The slide screw is most commonly used as transport devices in many types of machines, and is not intended for accurate positioning requirements.

STRUCTURE AND ADVANTAGES

The NB slide screw consists of two aluminum blocks, each with three radial bearings with a fixed angle between them. A round shaft is inserted between the two blocks, and its rotation produces linear motion determined by the contact angle between the shaft and the bearings. For variable loads, the thrust is adjusted by turning the spring loaded thrust adjustment bolts.

Linear Motion on Round-shaft

The NB slide screw is suitable for long-stroke applications using a standard linear shaft.

High Machine Efficiency

The slide screw utilizes the rotational motion of the bearings and drive shaft to achieve machine efficiency as high as 90%.

Figure I-1 Structure of NB Slide Screw

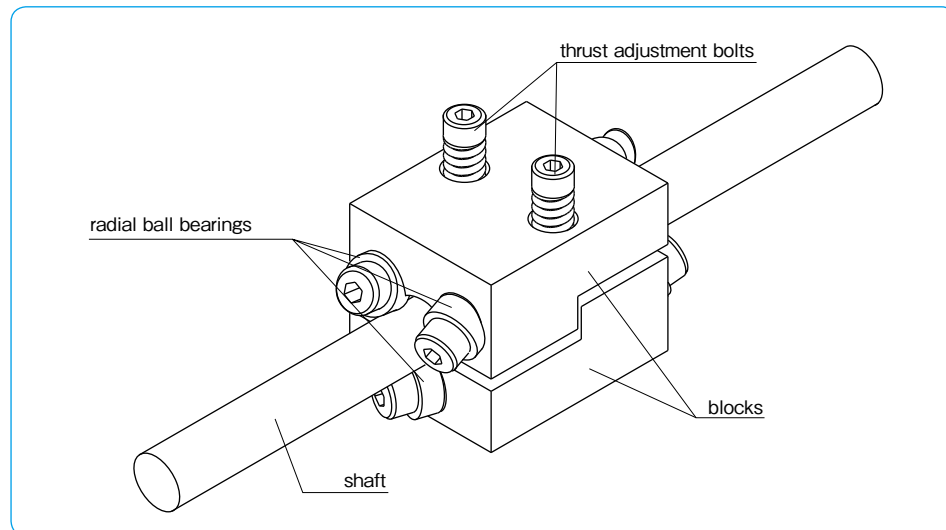

SIZE SELECTION

Required Thrust

Tightening of the bolts creates a thrust force by pushing the bearings against the shaft. This results in a constant force being applied to the bearings regardless of the load.

The thrust should not be greater than required force in the application.

For the horizontal application, the frictional resistance is calculated by the following equation.

$$F_1 = \mu \cdot g \cdot W \dots\dots\dots (1)$$

F₁: frictional resistance (N) μ: friction coefficient
W: mass of work (kg)
g: gravitational acceleration (9.8 m/sec²)

A sufficient safety margin should be achieved by setting μ = 0.01. Also, the inertia at starting and stopping should be taken into consideration.

$$F_2 = W \frac{dv}{dt} \dots\dots\dots (2)$$

F₂: inertia (N) W: mass of work (kg)
dv/dt: acceleration (9.8m/sec²)

Therefore, the required thrust is its maximum at starting point due to the combination of frictional resistance and inertia.

$$F = F_1 + F_2 \dots\dots\dots (3)$$

F: thrust (N) F₁: frictional resistance (N) F₂: inertia (N)

Rated Life

The rated life is expressed in terms of the number of revolutions of the drive shaft by Equation (4). The corresponding total travel distance and life time are given in Equations (5) and (6) respectively.

Rated life

$$L = \left(\frac{C_r}{F}\right)^3 10^6 \dots\dots\dots (4)$$

Total travel distance

$$L_s = \frac{L \cdot \ell}{10^6} \dots\dots\dots (5)$$

Life time

$$L_h = \frac{L}{60 \cdot n} \dots\dots\dots (6)$$

L: rated life (rev) C_r: basic dynamic load rating (thrust) (N)
F: thrust (N) L_s: travel life (km) ℓ: lead (mm)
L_h: life time (hr) n: revolutions per min (rpm)

Table I-1 Basic Dynamic Load Rating (Thrust)

part number	C _r :basic dynamic load rating (thrust) (N)
SS 6	98
SS 8	294
SS10	441
SS12	588
SS13	588
SS16	784
SS20	1,080
SS25	1,470
SS30	2,160

Allowable Rotational Speed

When the rotational speed is increased and approaches the shaft resonant frequency, the shaft is disabled from further operation. This speed is called the critical speed and can be obtained by the following equation. In order to leave a sufficient safety margin, the maximum operating speed should be set at about 80% of the calculated value.

$$N_c = \frac{60\lambda^2}{2\pi L^2} \cdot \sqrt{\frac{EI \times 10^3}{\gamma A}} \dots\dots\dots (7)$$

Nc: critical speed (rpm)
 E: modulus of direct elasticity (N/mm²)
 γ: density (kg/mm³)
 λ: installation coefficient (refer to Figure I-3)
 L: support distance (mm)
 I: geometrical moment of inertia (mm⁴)
 A: cross-sectional area of the shaft (mm²)

If modulus of direct elasticity is 2.06 × 10⁵ N/mm² and density is 7.85 × 10⁻⁶ kg/mm³, the critical speed for a solid shaft is:

$$N_c = 12.2 \cdot \frac{\lambda^2}{L^2} D \times 10^6 \dots\dots\dots (8)$$

Nc: critical speed (rpm)
 λ: installation coefficient (refer to Figure I-3)
 L: support distance (mm) D: shaft diameter (mm)

Figure I-2 Critical Speed and Support Distance

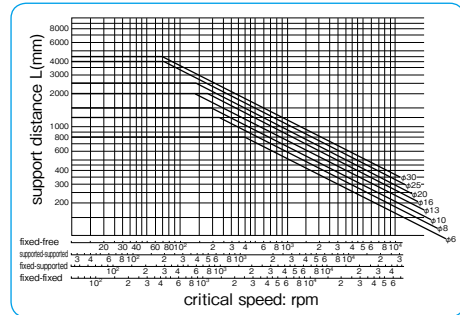
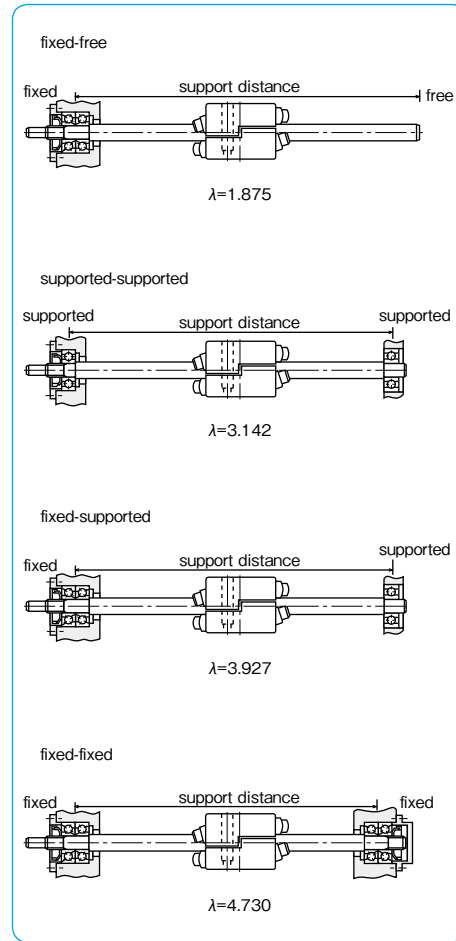

Figure I-3 Mounting of Slide Screw



Calculation Example

1. Selecting a slide screw that satisfies the following conditions:

- Support method: fixed-supported
- Support distance: 1,500 mm
- External force: 98 N
- Table mass: 50 kg
- Stroke distance: 1,200 mm
- Friction coefficient: 0.01
- Maximum speed of transfer: 12 m/min
- Cycles per minute: 4

● Determination of required thrust:
 F = 98 + (0.01 × 50 × 9.8) = 102.9 N

Therefore, based on the maximum thrust in the dimension table, at least SS10 is required in size.

● Allowable rotational speed:
 From Equation (8), according to the conditions, the critical speed Nc is.

$$N_c = 12.2 \cdot \frac{\lambda^2}{L^2} \cdot D \times 10^6 \quad \left[\begin{array}{l} \lambda = 3.927 \\ L = 1500 \text{mm} \end{array} \right]$$

$$= 83.6 \text{D rev}$$

Applying a safety factor of 0.8, the maximum speed is given by:

$$V_{max} = \frac{0.8 \cdot N_c \cdot \ell}{1000} \text{ m/min}$$

(ℓ: lead mm)

The following table summarizes the results of the calculations above for SS10 to SS16.

Table I-2 Maximum Speed

part number	shaft diameter D mm	lead ℓ mm	critical speed Nc rpm	maximum speed Vmax m/min
SS10-10	10	10	836	6.68
SS10-15		15		10.0
SS13-13	13	13	1,086	11.2
SS13-15		15		13.0
SS16-16	16	16	1,337	17.1

Therefore, the SS13-15 and SS16-16 slide screws satisfy the given conditions.

● Life Calculation

The life for the SS13-15 slide screw is calculated as follows. The rated life is obtained using Equation (4).

$$L = \left[\frac{C_F}{F} \right]^3 \times 10^6 = 186 \times 10^6 \text{ rev}$$

The average number of rotations that satisfies the conditions is:

$$n = \frac{1,200 \times 2 \times 4}{15} = 640 \text{ rev}$$

The life in terms of time is:

$$L_h = \frac{L}{60 \times n} = 4,840 \text{ (h)}$$

For the SS16-16 slide screw:

$$L = 4.40 \times 10^6 \text{ rev}$$

$$n = 600 \text{ rev}$$

$$L_h = 12,200 \text{ (h)}$$

2. Determining the maximum speed of transfer under the following conditions:

Support method: fixed-supported

Support distance: 2,000mm

Slide screw selected: SS16-16

The critical speed is obtained from Equation (8):

$$N_c = 12.2 \cdot \frac{\lambda^2}{L^2} \cdot D \times 10^6 \quad \left[\begin{array}{l} \lambda = 3.927 \\ L = 2000 \text{mm} \\ D = 16 \text{mm} \end{array} \right]$$

$$= 752 \text{ rpm}$$

Applying a safety factor of 0.8, the maximum speed of transfer is:

$$V_{max} = \frac{0.8 \cdot N_c \cdot \ell}{1000} \text{ m/min } (\ell: \text{lead mm})$$

$$= 9.6 \text{ m/min}$$

INSTALLATION

1. Clean dust from drive shaft.
2. Place shaft between upper and lower blocks. Lightly tighten thrust adjustment bolts until the clearance between the shaft and the bearings diminishes.
3. Temporarily attach the slide screw to the table.
4. Adjust the parallelism between the slide screw and the linear motion guides by manually moving the table back and forth. Fix the shaft accurately after the required parallelism is achieved.
5. Tighten the thrust adjustment bolts evenly while applying a thrust force to the table until slippage disappears. Care should be required to avoid excessive tightening which results in shortening the rated life.

USE AND HANDLING PRECAUTIONS

- It is recommended to use a heat-treated ground shaft such as NB shaft to prevent wear and to obtain smooth motion. (refer to page F-2)
- Since the slide screw utilizes the friction between the bearings and the shaft, the lead varies due to the effect of load variation, movement direction, and shaft conditions. As the values of standard lead are advisory, highly accurate positioning can be obtained by attaching a linear scale to the table.
- If the slide screw and linear motion guides are not parallel, an unbalanced load will be applied to the slide screw. Exercise care in controlling the parallelism.
- The slide screw slips on the shaft, if an excessive load is applied, in order to prevent damage. However, frequent slippage should be avoided in order not to shorten the travel life.
- Please transfer the radial load to linear motion guides since the radial load on the slide screw shortens the rated life. For long stroke applications, it is recommended to use linear and rotary motion components such as Slide Rotary Bush (refer to page E-8) along with a slide screw.

SPECIAL REQUIREMENTS

NB can fabricate slide screws to meet special requirements, including screws with a special lead or a reverse lead. Contact NB for further information.

SS TYPE

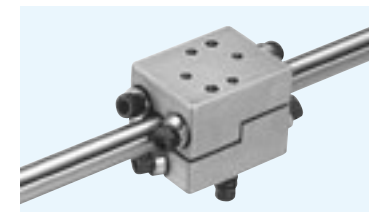

part number structure

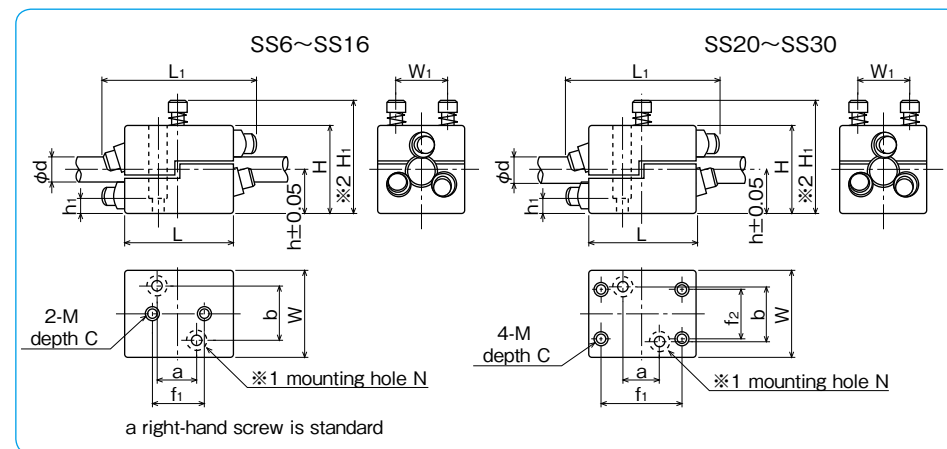
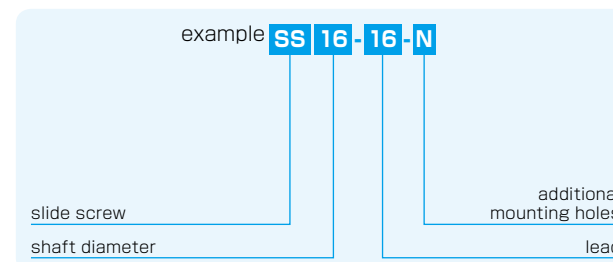

part number	shaft diameter d	major dimensions														standard lead ※3	maximum thrust	maximum tightening torque	mass	
		H	W	L	h	H ₁	L ₁	W ₁	f ₁	f ₂	a	b	M	C	N					h ₁
SS 6	6	20.5	20	25	10	28	36	12	10	—	—	—	M3	6.5	—	—	6, 9	24.5	0.03	0.03
SS 8	8	28.5	28	40	14	40	56	18	18	—	—	—	M4	9	—	—	8,12	73.5	0.14	0.09
SS10	10	36.5	36	46	18	51	62	24	20	—	20	24	M4	12	M4	8	10,15	118	0.25	0.17
SS12	12	40.5	40	50	20	54	72	25	25	—	20	25	M5	12.5	M4	10	12,18	147	0.31	0.22
SS13	13	40.5	40	50	20	54	72	25	25	—	20	25	M5	12.5	M4	10	13,15	147	0.31	0.22
SS16	16	50.5	50	60	25	62	86	32	30	—	25	32	M5	16	M5	10	16,24	196	0.41	0.39
SS20	20	60.5	60	70	30	71	97	40	50	40	30	40	M6	12	M6	10	20,30	265	0.56	0.57
SS25	25	76.5	76	80	38	82	110	50	60	50	32	50	M8	12	M8	15	25	392	1.1	1.05
SS30	30	89	90	88	44	92	127	60	60	70	36	60	M8	15	M8	15	30,45	539	1.4	1.65

※1 The mounting holes are machined on request.

※2 H₁ is the minimum height when the maximum thrust is applied.

※3 The values of standard lead are advisory.

1N≒0.102kgf 1N·m≒0.102kgf·m