

NBLINEAR SYSTEM

The NB linear system is a linear motion mechanism which utilizes the rolling motion of ball and/or roller elements. NB offers a wide range of linear motion products of high precision quality that contribute to the size and weight reduction of machinery and equipment.

ADVANTAGES

Low Friction and Excellent Response

The dynamic friction of the ball or roller elements is substantially lower than that of full-face surface sliding friction. Since the difference between dynamic and static frictional resistance is small, motion response is excellent in terms of positioning accuracy and in high speed applications with acceleration and deceleration.

High Precision and Smooth Movement

The NB linear system is designed for the rolling elements to achieve extremely smooth motion. The raceway surface is finished by precision grinding for high precision movement with optimal clearance.

High Load Capacity and Long Travel Life

Despite the compactness of the NB linear system, the system uses relatively large rolling elements on a long raceway resulting in a high load capacity and a long travel life.

Ease of Installation

The NB linear system shortens machining and assembly time compared with that of a full-face surface sliding bearing.

Variety of Types

A wide variety of types and sizes of the NB linear systems are available to best serve the purpose for every application and requirement.

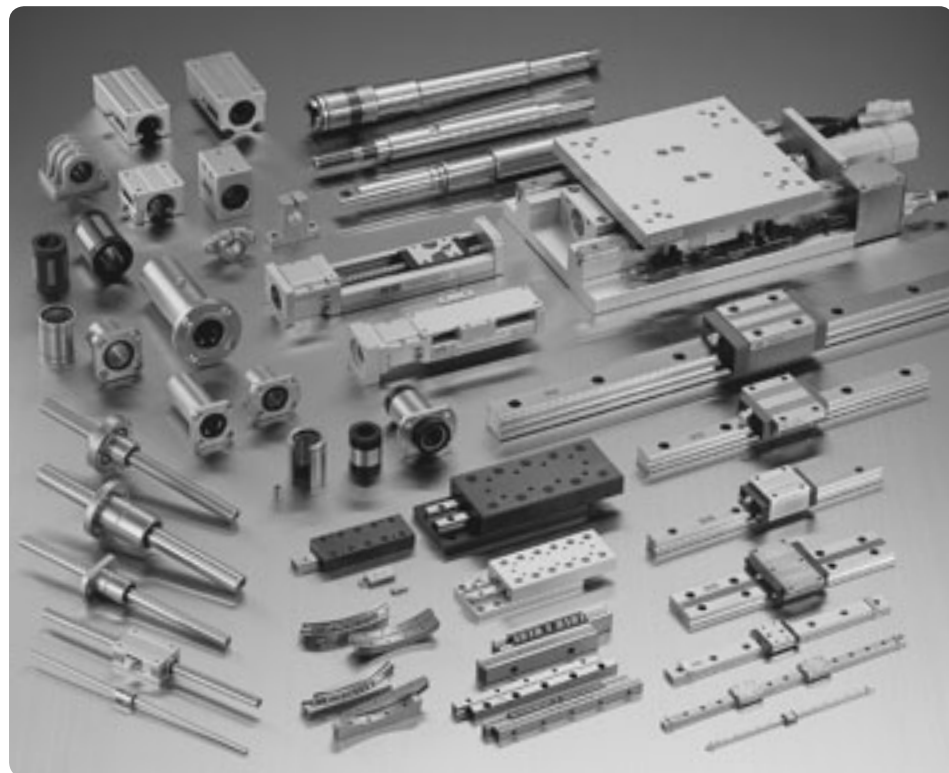

Eng-1

PROCESS FOR SELECTING NB LINEAR SYSTEM

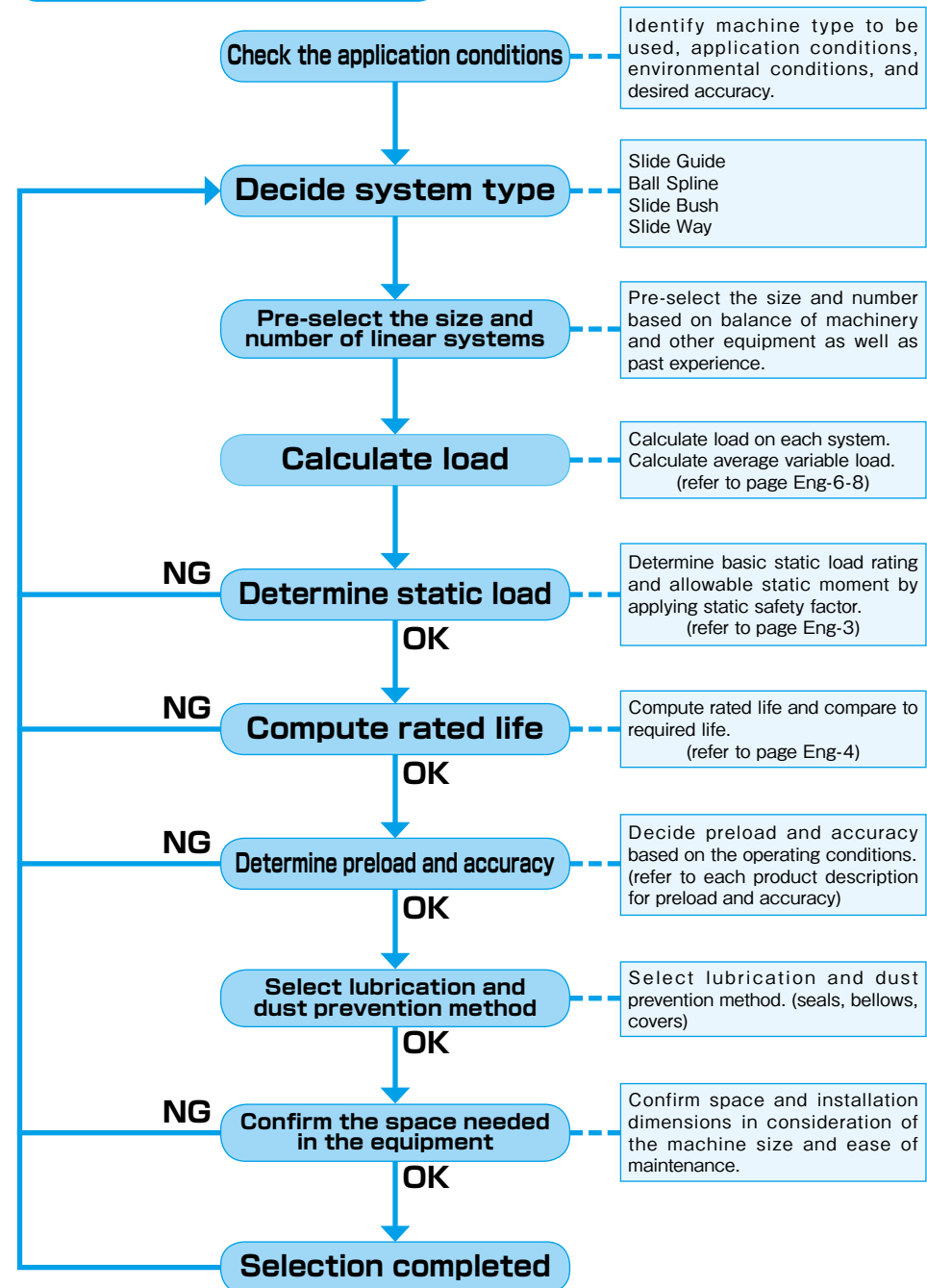

Eng-2

ALLOWABLE LOAD

Load and Moment

A load is applied to the linear system as Figure 1-1 shows. Sometimes moment loads are applied to, for example, slide guides. Load and moment are defined as follows.

Basic Static Load Rating (compliant with ISO14728-2*) and Allowable Static Moment

When excess load or impact load is applied to the linear system while it is stationary or moving slowly, a permanent deformation occurs on the rolling elements and the race way.

If this deformation exceeds a certain limit, it causes vibration and noise during operation resulting in a non-smooth motion and a shorter life time. To prevent this permanent deformation and deterioration in motion accuracy, the basic static load rating (Co) is given as the allowable load for the linear system. This basic static load rating is defined as the static load that results in the maximum allowable stress at the center of the contact surface between the rolling elements and the race way. The sum of the permanent deformation of the rolling element and that of the race way is 0.0001 time the diameter of the rolling element. In the linear system, a moment load may be present in addition to the static load. The allowable static moments are defined by Mp, My, and Mr as illustrated in Figure 1-1.

*1: This does not apply to some products.

Allowable Load and Static Safety Factor

The basic static load rating and allowable static moment define the maximum static load in each direction, however, these maximum static loads are not necessarily applicable depending on the operating conditions, the mounting accuracy, and the required motion accuracy. Therefore, an allowable load with a safety factor must be obtained. The minimum static safety factor is listed in Table 1-1.

Allowable Load

$$P_{max} \leq Co / fs \dots\dots\dots (1)$$

Allowable Moment

$$M_{max} \leq (Mp, My, Mr, Mp2, My2) / fs \dots\dots (2)$$

fs: static safety factor Co: basic static load rating (N)

Pmax.: allowable load (N)

Mp, Mr, My, Mp2, My2: allowable static moment (N · m)

Mmax.: allowable moment (N · m)

Table 1-1 Minimum Static Safety Factor (fs)

operating conditions	static safety factor
normal	1~2
smooth motion required	2~4
vibration/impact loading	3~5

Figure 1-1 Load and Moment

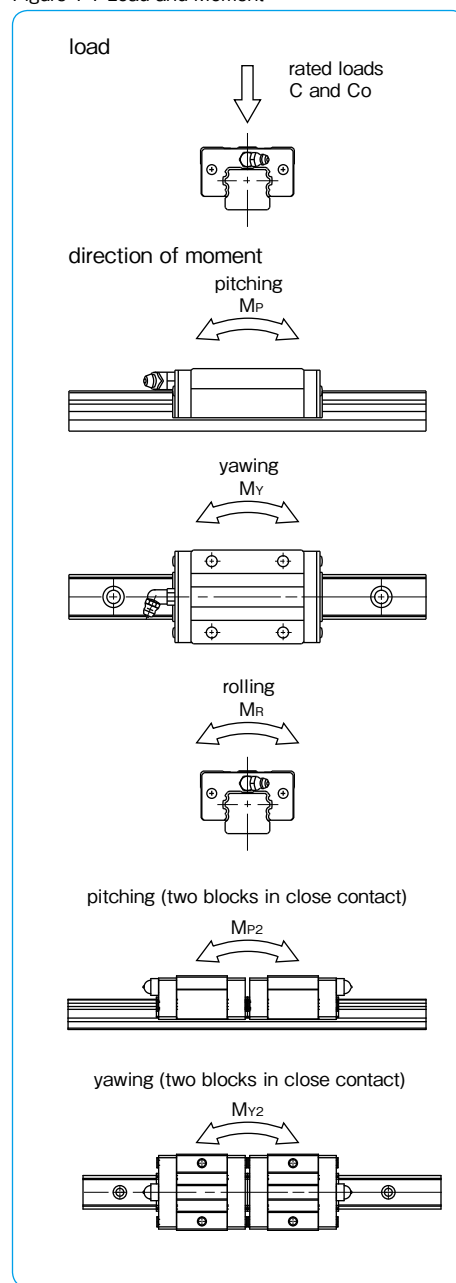

LIFE

Life of a Linear System

When a linear system reciprocates under loading, a continuous stress acts on it, ultimately causing flaking of its race way surface due to material fatigue. The distance a linear system travels before this flaking occurs is defined as the life of the linear system. A linear system can also become inoperable due to sintering, cracking, pitting, or rusting, however, these causes are differentiated from flaking because they are related to installation accuracy, operating environment, and relubrication method.

Rated Life

Even when a group of linear systems from the same production lot operated under identical conditions, the life time can differ due to differences in the material fatigue failure characteristics. This fact prevents from determining the exact life time of a single linear system for use. Therefore, the rated life is defined statistically as the distance of 90% of the linear systems travel before causing flaking.

Basic Dynamic Load Rating (compliant with ISO14728-1*2) and Basic Dynamic Torque Rating

The life of a linear system is expressed in terms of the distance traveled. Therefore, the life of a linear system is calculated reversely by using the allowable load that achieves a certain travel distance. This allowable load is called the basic dynamic load rating. The basic dynamic load rating is defined as a constant load in weight and direction that can achieve a travel distance of 50x10³m on the linear system. NB assumes the load is applied from the top as a normal radial load, because basic dynamic load ratings change depending on the applied load direction. The basic dynamic load ratings in the dimensional tables are based on this assumption. Ball splines can carry torque loading, so the basic dynamic torque rating is defined for the Ball Spline.

*2: This does not apply to some products.

Rated Life Estimation

The rated life estimation depends on the type of the rolling element. Equations (3) and (4) are used for the ball element and for the roller element, respectively. Equation (5) is used when torque loading is present.

balls are used as the rolling element

$$L = \left(\frac{C}{P}\right)^3 \cdot 50 \dots\dots\dots (3)$$

rollers are used as the rolling element

$$L = \left(\frac{C}{P}\right)^{10/3} \cdot 50 \dots\dots\dots (4)$$

torque loading is present

$$L = \left(\frac{CT}{T}\right)^3 \cdot 50 \dots\dots\dots (5)$$

L: rated life (km) C: basic dynamic load rating (N)
 P: applied load (N) Cr: basic dynamic torque rating (N · m)
 T: applied torque (N · m)

In the actual application, numerous variable factors are present such as in guide rail/shaft accuracy, in mounting conditions, in operating conditions, vibration and shock, etc. Therefore, calculating the actual applied load accurately is extremely difficult. In general, the calculation is simplified by using coefficients representing these factors: hardness coefficient (fh), temperature coefficient (ft), contact coefficient (fc), and applied load coefficient (fw). Taking these coefficients into account, Equations (3) to (5) become Equations (6) to (8).

balls are used as the rolling element

$$L = \left(\frac{fh \cdot ft \cdot fc \cdot C}{fw \cdot P}\right)^3 \cdot 50 \dots\dots\dots (6)$$

rollers are used as the rolling element

$$L = \left(\frac{fh \cdot ft \cdot fc \cdot C}{fw \cdot P}\right)^{10/3} \cdot 50 \dots\dots\dots (7)$$

torque loading is present

$$L = \left(\frac{fh \cdot ft \cdot fc \cdot CT}{fw \cdot T}\right)^3 \cdot 50 \dots\dots\dots (8)$$

L: rated life (km) fh: hardness coefficient
 ft: temperature coefficient fc: contact coefficient
 fw: applied load coefficient P: applied load (N)
 C: basic dynamic load rating (N)
 CT: basic dynamic torque rating (N · m)
 T: applied torque (N · m)

When the travel distance per unit time is constant, the rated life can be expressed in terms of time (hour). Equation (9) shows the relationship between stroke length, number of cycles per minute, and the life time.

$$L_h = \frac{L \cdot 10^3}{2 \cdot \ell_s \cdot n_1 \cdot 60} \dots \dots \dots (9)$$

L_h: life time (hr) ℓ_s: stroke length (m)
n₁: number of cycles per minute (cpm)

Figure 1-2 Hardness Coefficient

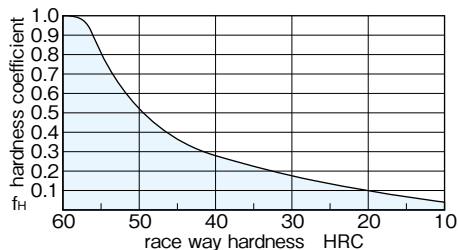

Figure 1-3 Temperature Coefficient

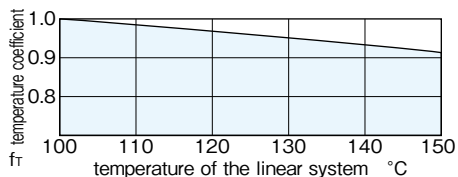

Table 1-2 Contact Coefficient

number of linear bearings in close contact on rail/shaft	contact coefficient f _c
1	1.00
2	0.81
3	0.72
4	0.66
5	0.61

Table 1-3 Applied Load Coefficient

operating conditions		applied load coefficient f _w
loading	velocity	
no shock and vibration	0.25 m/s less	1.0~1.5
low shock and vibration	1 m/s less	1.5~2.0
high shock and vibration	1 m/s more	2.0~3.5

•Hardness Coefficient (f_H)

In the linear system, the guide rail or shaft works as race way of the rolling elements. Therefore, the hardness of the rail or shaft is an important factor in determining the rated load. The rated load decreases as the hardness decrease below 58HRC. NB products hold appropriate hardness by advanced heat treatment technology. In case of using the rail or shaft of insufficient hardness, please take the hardness coefficient (Figure 1-2) into the life calculation equation.

•Temperature Coefficient (f_T)

In order to give low wear characteristics NB products are hardened by heat treatment. If the temperature of the linear system exceeds 100°C, the hardness is decreased by tempering effect, so as the rated load decreases. Figure 1-3 shows the temperature coefficient as hardness changes with temperature.

•Contact Coefficient (f_c)

When more than one bearing is used in close contact, the contact coefficient should be taken into consideration due to the variation of products and the accuracy of the mounting surface. Table 1-2 shows the contact coefficient for life calculation.

•Applied Load Coefficient (f_w)

The actual applied load on a liner system can be greater than the calculated load due to impact, vibration, or inertia. Hence, an appropriate applied load coefficient(table 1-3) must be incorporated into a life calculation.

There are separate applied load coefficient tables for TOPBALL products on page D-3 and for Slide Rotary Bush FR&FRA type on page E-25.

Calculation of Applied Load (1)

Tables 1-4 and 1-5 show the formulas of applied load calculation for typical applications.

W: applied load (N) P₁ - P₄: load applied to linear system (N) X,Y: linear system span (mm)
x, y, ℓ: distance to applied load or to working center of gravity (mm) g: gravitational acceleration (9.8 x 10³mm/s²)
V: velocity (mm/s) t: acceleration time (sec) t_s: deceleration time (sec)

Table 1-4 Applied Load Calculation (1)

	condition	applied load calculation formula
under static conditions or constant velocity motion	2 horizontal axes 	
	2 horizontal axes, over-hang 	$P_1 = \frac{1}{4}W + \frac{X_0}{2X}W + \frac{Y_0}{2Y}W$ $P_2 = \frac{1}{4}W - \frac{X_0}{2X}W + \frac{Y_0}{2Y}W$ $P_3 = \frac{1}{4}W + \frac{X_0}{2X}W - \frac{Y_0}{2Y}W$ $P_4 = \frac{1}{4}W - \frac{X_0}{2X}W - \frac{Y_0}{2Y}W$ <p>Note : If the calculation results in a negative value, the loading direction is in the opposite direction.</p>
	2 horizontal axes, moving axes 	

Table 1-5 Applied Load Calculation (2)

	condition	applied load calculation formula
under static conditions or constant velocity motion	2 horizontal, side axes 	$P_1=P_2=P_3=P_4=\frac{l_1}{2Y}W$ $P_{1S}=P_{3S}=\frac{1}{4}W+\frac{X_0}{2X}W$ $P_{2S}=P_{4S}=\frac{1}{4}W-\frac{X_0}{2X}W$
	2 vertical axes 	$P_1=P_2=P_3=P_4=\frac{l_1}{2X}W$ $P_{1S}=P_{2S}=P_{3S}=P_{4S}=\frac{l_2}{2X}W$
under constant acceleration conditions	2 horizontal axes 	under acceleration $P_1=P_3=\frac{1}{4}W\left(1+\frac{2V_1l_1}{gt_1X}\right)$ $P_2=P_4=\frac{1}{4}W\left(1-\frac{2V_1l_1}{gt_1X}\right)$ under deceleration $P_1=P_3=\frac{1}{4}W\left(1-\frac{2V_1l_1}{gt_3X}\right)$ $P_2=P_4=\frac{1}{4}W\left(1+\frac{2V_1l_1}{gt_3X}\right)$ under constant velocity $P_1=P_2=P_3=P_4=\frac{1}{4}W$ ※g: acceleration of gravity (9.8×10 ³ mm/sec ²)
	velocity diagram 	

• Equivalent Coefficient

The linear systems are generally used with two axes, each axis with a couple of bearings installed. However, due to a space limitation, there must be an application in which one axis with one or two bearings in close contact installed. In such a case, multiply the applied moment by the equivalent moment coefficient shown in Tables 1-7~1-25 for applied load calculation. The following is a formula for calculating the equivalent moment load when a moment is applied to the linear system.

$P=E \cdot M$

P: equivalent moment load per bearing (N)
 E: equivalent moment coefficient
 M: applied moment (N · mm)

Calculation of Applied Load (2)

Table 1-6 shows the formulas for determining the applied load when moment is applied to the linear system.

W: applied load (N) P: load applied to the linear system (N) l: distance to applied load or to working center of gravity (mm)

Table 1-6 Applied Load Calculation (3)

	condition	applied load calculation formula
1 axis application	1 horizontal axis, 1 bearing 	$P=W+E_{p1}Wl_1+E_rWl_2$ E _{p1} : Mp equivalent coefficient with 1 bearing used E _r : Mr equivalent coefficient
	1 sideways axis, 1 bearing 	$P=W+E_{y1}Wl_1+E_rWl_2$ E _{y1} : My equivalent coefficient with 1 bearing used E _r : Mr equivalent coefficient
	1 vertical axis, 1 bearing 	$P=E_{p1}Wl_1+E_{y1}Wl_2$ E _{p1} : Mp equivalent coefficient with 1 bearing used E _{y1} : My equivalent coefficient with 1 bearing used
2 axes application	2 horizontal axes, 1 bearing each 	$P=W/2+Wl_2/Y+E_{p1}Wl_1/2$ E _{p1} : Mp equivalent coefficient with 1 bearing used Y: span between the two axes centers
	2 sideways axes, 1 bearing each 	$P=W/2+E_{y1}Wl_2/2+Wl_1/Y$ E _{y1} : My equivalent coefficient with 1 bearing used Y: span between the two axes centers
	2 vertical axes, 1 bearing each 	$P=E_{p1}Wl_1/2+E_{y1}Wl_2/2$ E _{p1} : Mp equivalent coefficient with 1 bearing used E _{y1} : My equivalent coefficient with 1 bearing used

Table 1-7 Slide Guide SEB type

unit: 1/mm

part number	equivalent coefficient				
	Ep ₁	Ep ₂	Ey ₁	Ey ₂	Er
SEBS 5B	6.64×10 ⁻¹	9.61×10 ⁻²	7.91×10 ⁻¹	1.15×10 ⁻¹	3.85×10 ⁻¹
SEBS 5BY	5.17×10 ⁻¹	8.38×10 ⁻²	6.16×10 ⁻¹	9.99×10 ⁻²	3.85×10 ⁻¹
SEBS 7BS	6.70×10 ⁻¹	7.76×10 ⁻²	7.98×10 ⁻¹	9.25×10 ⁻²	2.74×10 ⁻¹
SEBS 7B	4.62×10 ⁻¹	6.65×10 ⁻²	5.50×10 ⁻¹	7.93×10 ⁻²	2.74×10 ⁻¹
SEBS 7BY	2.84×10 ⁻¹	5.00×10 ⁻²	3.38×10 ⁻¹	5.96×10 ⁻²	2.74×10 ⁻¹
SEBS 9BS	5.83×10 ⁻¹	6.96×10 ⁻²	6.95×10 ⁻¹	8.30×10 ⁻²	2.15×10 ⁻¹
SEBS 9B	3.26×10 ⁻¹	5.26×10 ⁻²	3.88×10 ⁻¹	6.27×10 ⁻²	2.15×10 ⁻¹
SEBS 9BY	2.26×10 ⁻¹	4.14×10 ⁻²	2.69×10 ⁻¹	4.94×10 ⁻²	2.15×10 ⁻¹
SEBS12BS	5.27×10 ⁻¹	5.90×10 ⁻²	6.28×10 ⁻¹	7.03×10 ⁻²	1.60×10 ⁻¹
SEBS12B	3.08×10 ⁻¹	4.71×10 ⁻²	3.67×10 ⁻¹	5.61×10 ⁻²	1.60×10 ⁻¹
SEBS12BY	2.02×10 ⁻¹	3.64×10 ⁻²	2.41×10 ⁻¹	4.33×10 ⁻²	1.60×10 ⁻¹
SEBS15BS	3.95×10 ⁻¹	5.01×10 ⁻²	4.71×10 ⁻¹	5.97×10 ⁻²	1.30×10 ⁻¹
SEBS15B	2.31×10 ⁻¹	3.85×10 ⁻²	2.75×10 ⁻¹	4.58×10 ⁻²	1.29×10 ⁻¹
SEBS15BY	1.52×10 ⁻¹	2.90×10 ⁻²	1.81×10 ⁻¹	3.45×10 ⁻²	1.29×10 ⁻¹
SEBS20B	1.41×10 ⁻¹	2.47×10 ⁻²	1.68×10 ⁻¹	2.94×10 ⁻²	9.76×10 ⁻²
SEBS20BY	1.01×10 ⁻¹	1.95×10 ⁻²	1.20×10 ⁻¹	2.32×10 ⁻²	9.76×10 ⁻²
SEBS 5WB	4.51×10 ⁻¹	7.70×10 ⁻²	5.37×10 ⁻¹	9.17×10 ⁻²	1.96×10 ⁻¹
SEBS 5WBY	3.25×10 ⁻¹	6.15×10 ⁻²	3.88×10 ⁻¹	7.33×10 ⁻²	1.96×10 ⁻¹
SEBS 7WBS	5.83×10 ⁻¹	6.96×10 ⁻²	6.95×10 ⁻¹	8.30×10 ⁻²	1.40×10 ⁻¹
SEBS 7WB	3.26×10 ⁻¹	5.26×10 ⁻²	3.88×10 ⁻¹	6.27×10 ⁻²	1.40×10 ⁻¹
SEBS 7WBY	2.26×10 ⁻¹	4.14×10 ⁻²	2.69×10 ⁻¹	4.94×10 ⁻²	1.40×10 ⁻¹
SEBS 9WBS	4.63×10 ⁻¹	6.05×10 ⁻²	5.52×10 ⁻¹	7.21×10 ⁻²	1.09×10 ⁻¹
SEBS 9WB	2.41×10 ⁻¹	4.23×10 ⁻²	2.87×10 ⁻¹	5.04×10 ⁻²	1.08×10 ⁻¹
SEBS 9WBY	1.71×10 ⁻¹	3.31×10 ⁻²	2.03×10 ⁻¹	3.94×10 ⁻²	1.08×10 ⁻¹
SEBS12WBS	3.89×10 ⁻¹	5.28×10 ⁻²	4.64×10 ⁻¹	6.29×10 ⁻²	8.17×10 ⁻²
SEBS12WB	2.17×10 ⁻¹	3.81×10 ⁻²	2.59×10 ⁻¹	4.55×10 ⁻²	8.16×10 ⁻²
SEBS12WBY	1.51×10 ⁻¹	2.94×10 ⁻²	1.79×10 ⁻¹	3.50×10 ⁻²	8.16×10 ⁻²
SEBS15WBS	2.58×10 ⁻¹	4.06×10 ⁻²	3.07×10 ⁻¹	4.83×10 ⁻²	4.71×10 ⁻²
SEBS15WB	1.63×10 ⁻¹	3.03×10 ⁻²	1.94×10 ⁻¹	3.61×10 ⁻²	4.71×10 ⁻²
SEBS15WBY	1.13×10 ⁻¹	2.29×10 ⁻²	1.35×10 ⁻¹	2.73×10 ⁻²	4.71×10 ⁻²

Ep₁: Mp equivalent coefficient with 1 block used Ep₂: Mp equivalent coefficient with 2 blocks used in close contact
 Ey₁: My equivalent coefficient with 1 block used Ey₂: My equivalent coefficient with 2 blocks used in close contact
 Er: Mr equivalent coefficient

Table 1-8 Slide Guide SEB and SER type

unit: 1/mm

part number	equivalent coefficient				
	Ep ₁	Ep ₂	Ey ₁	Ey ₂	Er
SEBS 2A	7.06×10 ⁻¹	1.37×10 ⁻¹	5.92×10 ⁻¹	1.15×10 ⁻¹	9.09×10 ⁻¹
SEBS 3A	9.16×10 ⁻¹	1.49×10 ⁻¹	7.69×10 ⁻¹	1.25×10 ⁻¹	6.25×10 ⁻¹
SEBS 3AY	6.02×10 ⁻¹	1.13×10 ⁻¹	5.05×10 ⁻¹	9.48×10 ⁻²	6.25×10 ⁻¹
SEBS 5A	6.11×10 ⁻¹	1.01×10 ⁻¹	5.13×10 ⁻¹	8.46×10 ⁻²	3.85×10 ⁻¹
SEBS 5AY	4.65×10 ⁻¹	8.45×10 ⁻²	3.90×10 ⁻¹	7.09×10 ⁻²	3.85×10 ⁻¹
SEBS 7A	4.62×10 ⁻¹	7.48×10 ⁻²	3.87×10 ⁻¹	6.27×10 ⁻²	2.74×10 ⁻¹
SEBS 7AY	2.84×10 ⁻¹	5.49×10 ⁻²	2.38×10 ⁻¹	4.61×10 ⁻²	2.74×10 ⁻¹
SEB(S) 9A	3.32×10 ⁻¹	5.89×10 ⁻²	2.78×10 ⁻¹	4.94×10 ⁻²	2.20×10 ⁻¹
SEB(S) 9AY	2.25×10 ⁻¹	4.46×10 ⁻²	1.89×10 ⁻¹	3.74×10 ⁻²	2.20×10 ⁻¹
SEB(S) 12A	3.08×10 ⁻¹	5.62×10 ⁻²	2.58×10 ⁻¹	4.72×10 ⁻²	1.60×10 ⁻¹
SEB(S) 12AY	2.02×10 ⁻¹	4.11×10 ⁻²	1.70×10 ⁻¹	3.45×10 ⁻²	1.60×10 ⁻¹
SEB(S) 15A	2.31×10 ⁻¹	4.30×10 ⁻²	1.94×10 ⁻¹	3.61×10 ⁻²	1.29×10 ⁻¹
SEB(S) 15AY	1.52×10 ⁻¹	3.12×10 ⁻²	1.27×10 ⁻¹	2.62×10 ⁻²	1.29×10 ⁻¹
SEB(S) 20A	1.53×10 ⁻¹	3.03×10 ⁻²	1.28×10 ⁻¹	2.54×10 ⁻²	9.76×10 ⁻²
SEB(S) 20AY	1.01×10 ⁻¹	2.16×10 ⁻²	8.44×10 ⁻²	1.81×10 ⁻²	9.76×10 ⁻²
SEBS 3WA	6.74×10 ⁻¹	1.14×10 ⁻¹	5.42×10 ⁻¹	9.58×10 ⁻²	3.23×10 ⁻¹
SEBS 3WAY	4.48×10 ⁻¹	8.78×10 ⁻²	3.76×10 ⁻¹	7.37×10 ⁻²	3.23×10 ⁻¹
SEBS 7WA(D)	3.26×10 ⁻¹	5.56×10 ⁻²	2.73×10 ⁻¹	4.67×10 ⁻²	1.40×10 ⁻¹
SEBS 7WAY	2.26×10 ⁻¹	4.32×10 ⁻²	1.90×10 ⁻¹	3.63×10 ⁻²	1.40×10 ⁻¹
SEB(S) 9WA(D)	2.41×10 ⁻¹	4.72×10 ⁻²	2.02×10 ⁻¹	3.96×10 ⁻²	1.08×10 ⁻¹
SEB(S) 9WAY	1.71×10 ⁻¹	3.58×10 ⁻²	1.43×10 ⁻¹	3.00×10 ⁻²	1.08×10 ⁻¹
SEB(S) 12WA	2.02×10 ⁻¹	4.13×10 ⁻²	1.70×10 ⁻¹	3.46×10 ⁻²	8.16×10 ⁻²
SEB(S) 12WAY	1.43×10 ⁻¹	3.10×10 ⁻²	1.20×10 ⁻¹	2.60×10 ⁻²	8.16×10 ⁻²
SEB(S) 15WA	1.63×10 ⁻¹	3.29×10 ⁻²	1.37×10 ⁻¹	2.76×10 ⁻²	4.71×10 ⁻²
SEB(S) 15WAY	1.13×10 ⁻¹	2.43×10 ⁻²	9.48×10 ⁻²	2.04×10 ⁻²	4.71×10 ⁻²
SER(S) 9A	2.49×10 ⁻¹	4.15×10 ⁻²	2.15×10 ⁻¹	3.58×10 ⁻²	1.50×10 ⁻¹
SER(S) 12A	2.50×10 ⁻¹	4.16×10 ⁻²	2.23×10 ⁻¹	3.71×10 ⁻²	1.33×10 ⁻¹
SER(S) 15A	1.99×10 ⁻¹	3.32×10 ⁻²	1.79×10 ⁻¹	2.98×10 ⁻²	1.05×10 ⁻¹
SER(S) 20A	1.66×10 ⁻¹	2.77×10 ⁻²	1.47×10 ⁻¹	2.45×10 ⁻²	6.49×10 ⁻²
SER(S) 9WA	1.52×10 ⁻¹	2.53×10 ⁻²	1.36×10 ⁻¹	2.26×10 ⁻²	7.17×10 ⁻²
SER(S) 12WA	1.42×10 ⁻¹	2.36×10 ⁻²	1.28×10 ⁻¹	2.13×10 ⁻²	5.86×10 ⁻²
SER(S) 15WA	1.60×10 ⁻¹	2.66×10 ⁻²	1.45×10 ⁻¹	2.41×10 ⁻²	4.15×10 ⁻²

Ep₁: Mp equivalent coefficient with 1 block used Ep₂: Mp equivalent coefficient with 2 blocks used in close contact
 Ey₁: My equivalent coefficient with 1 block used Ey₂: My equivalent coefficient with 2 blocks used in close contact
 Er: Mr equivalent coefficient

Table 1-9 Slide Guide SGL, SGW type unit: 1/mm

part number	equivalent coefficient				Er
	Ep ₁	Ep ₂	Ey ₁	Ey ₂	
SGL15F (E)	2.57×10 ⁻¹	3.75×10 ⁻²	2.57×10 ⁻¹	3.75×10 ⁻²	1.28×10 ⁻¹
SGL20F (E)	2.06×10 ⁻¹	3.31×10 ⁻²	2.06×10 ⁻¹	3.31×10 ⁻²	9.31×10 ⁻²
SGL25F (E)	1.72×10 ⁻¹	2.81×10 ⁻²	1.72×10 ⁻¹	2.81×10 ⁻²	8.31×10 ⁻²
SGL30F (E)	1.47×10 ⁻¹	2.28×10 ⁻²	1.47×10 ⁻¹	2.28×10 ⁻²	6.88×10 ⁻²
SGL35F (E)	1.29×10 ⁻¹	2.02×10 ⁻²	1.29×10 ⁻¹	2.02×10 ⁻²	5.45×10 ⁻²
SGL15TF (TE)	1.63×10 ⁻¹	2.87×10 ⁻²	1.63×10 ⁻¹	2.87×10 ⁻²	1.29×10 ⁻¹
SGL20TF (TE)	1.41×10 ⁻¹	2.59×10 ⁻²	1.41×10 ⁻¹	2.59×10 ⁻²	9.28×10 ⁻²
SGL25TF (TE)	1.09×10 ⁻¹	2.09×10 ⁻²	1.09×10 ⁻¹	2.09×10 ⁻²	8.31×10 ⁻²
SGL30TF (TE)	9.32×10 ⁻²	1.71×10 ⁻²	9.32×10 ⁻²	1.71×10 ⁻²	6.87×10 ⁻²
SGL35TF (TE)	8.14×10 ⁻²	1.51×10 ⁻²	8.14×10 ⁻²	1.51×10 ⁻²	5.49×10 ⁻²
SGL15HTF (HTE,HTEX)	1.63×10 ⁻¹	2.87×10 ⁻²	1.63×10 ⁻¹	2.87×10 ⁻²	1.29×10 ⁻¹
SGL20HTF (HTE,HTEX)	1.22×10 ⁻¹	2.33×10 ⁻²	1.22×10 ⁻¹	2.33×10 ⁻²	9.29×10 ⁻²
SGL25HTF (HTE,HTEX)	1.09×10 ⁻¹	2.09×10 ⁻²	1.09×10 ⁻¹	2.09×10 ⁻²	8.31×10 ⁻²
SGL30HTF (HTE,HTEX)	9.32×10 ⁻²	1.71×10 ⁻²	9.32×10 ⁻²	1.71×10 ⁻²	6.87×10 ⁻²
SGL35HTF (HTE,HTEX)	8.14×10 ⁻²	1.51×10 ⁻²	8.14×10 ⁻²	1.51×10 ⁻²	5.49×10 ⁻²
SGL15HYF (HTE,HTEX)	1.08×10 ⁻¹	2.13×10 ⁻²	1.08×10 ⁻¹	2.13×10 ⁻²	1.28×10 ⁻¹
SGL20HYF (HTE,HTEX)	8.61×10 ⁻²	1.79×10 ⁻²	8.61×10 ⁻²	1.79×10 ⁻²	9.31×10 ⁻²
SGL25HYF (HTE,HTEX)	7.54×10 ⁻²	1.57×10 ⁻²	7.54×10 ⁻²	1.57×10 ⁻²	8.32×10 ⁻²
SGL30HYF (HTE,HTEX)	6.47×10 ⁻²	1.30×10 ⁻²	6.47×10 ⁻²	1.30×10 ⁻²	6.90×10 ⁻²
SGL35HYF (HTE,HTEX)	5.65×10 ⁻²	1.15×10 ⁻²	5.65×10 ⁻²	1.15×10 ⁻²	5.46×10 ⁻²
SGL45HYF (HTE,HTEX)	5.00×10 ⁻²	1.01×10 ⁻²	5.00×10 ⁻²	1.01×10 ⁻²	4.35×10 ⁻²
SGW17TF (TE)	2.00×10 ⁻¹	3.28×10 ⁻²	2.00×10 ⁻¹	3.28×10 ⁻²	5.35×10 ⁻²
SGW21TF (TE)	1.67×10 ⁻¹	2.89×10 ⁻²	1.67×10 ⁻¹	2.89×10 ⁻²	4.78×10 ⁻²
SGW27TF (TE)	1.26×10 ⁻¹	2.31×10 ⁻²	1.26×10 ⁻¹	2.31×10 ⁻²	4.33×10 ⁻²
SGW35TF (TE)	8.39×10 ⁻²	1.56×10 ⁻²	8.39×10 ⁻²	1.56×10 ⁻²	2.62×10 ⁻²

Ep₁: Mp equivalent coefficient with 1 block used Ep₂: Mp equivalent coefficient with 2 blocks used in close contact
 Ey₁: My equivalent coefficient with 1 block used Ey₂: My equivalent coefficient with 2 blocks used in close contact
 Er: Mr equivalent coefficient

Table 1-10 Ball Spline · Rotary Ball Spline unit: 1/mm

part number	equivalent coefficient		E ₁	E ₂
	E ₁	E ₂		
SSP 4	—	—	6.19×10 ⁻¹	1.18×10 ⁻¹
SSP 6	SPR 6	—	4.47×10 ⁻¹	5.70×10 ⁻²
SSP 8	SPR 8	—	3.88×10 ⁻¹	5.74×10 ⁻²
SSP 10	SPR 10	—	2.82×10 ⁻¹	4.37×10 ⁻²
SSP 13A	SPR 13	—	3.57×10 ⁻¹	4.49×10 ⁻²
SSP 16A	SPR 16	SPB 16	2.43×10 ⁻¹	3.75×10 ⁻²
SSP 20A	SPR 20A	SPB 20	1.48×10 ⁻¹	2.91×10 ⁻²
SSP 25A	SPR 25A	SPB 25	1.37×10 ⁻¹	2.27×10 ⁻²
SSP 30A	SPR 30A	—	1.28×10 ⁻¹	1.58×10 ⁻²
SSP 40A	SPR 40A	—	1.05×10 ⁻¹	1.28×10 ⁻²
SSP 50A	SPR 50A	—	9.41×10 ⁻²	1.59×10 ⁻²
SSP 60A	SPR 60A	—	9.02×10 ⁻²	1.45×10 ⁻²
SSP 80	—	—	6.70×10 ⁻²	1.21×10 ⁻²
SSP 80L	—	—	4.56×10 ⁻²	9.53×10 ⁻³
SSP100	—	—	5.92×10 ⁻²	1.03×10 ⁻²
SSP100L	—	—	4.06×10 ⁻²	7.90×10 ⁻³
SSP 20	SPR 20	—	1.79×10 ⁻¹	2.26×10 ⁻²
SSP 25	SPR 25	—	1.55×10 ⁻¹	1.94×10 ⁻²
SSP 30	SPR 30	—	1.28×10 ⁻¹	1.58×10 ⁻²
SSP 40	SPR 40	—	1.05×10 ⁻¹	1.28×10 ⁻²
SSP 50	SPR 50	—	1.07×10 ⁻¹	1.69×10 ⁻²
SSP 60	SPR 60	—	9.77×10 ⁻²	1.44×10 ⁻²
SPLFS 6			2.68×10 ⁻¹	6.67×10 ⁻²
SPLFS 8			2.57×10 ⁻¹	6.48×10 ⁻²
SPLFS 10			2.09×10 ⁻¹	5.25×10 ⁻²
SPLFS 13			1.96×10 ⁻¹	4.90×10 ⁻²
SPLFS 16			1.59×10 ⁻¹	3.97×10 ⁻²

E₁: equivalent moment coefficient with 1 nut used
 E₂: equivalent moment coefficient with 2 nuts used in close contact

unit: 1/mm

part number	equivalent coefficient			
	Ep ₁	Ep ₂	Ey ₁	Ey ₂
SSP4AM	7.33×10 ⁻¹	1.31×10 ⁻¹	4.23×10 ⁻¹	7.54×10 ⁻²
SSP5AM	5.53×10 ⁻¹	8.64×10 ⁻²	4.55×10 ⁻¹	7.10×10 ⁻²

EP₁: Mp equivalent coefficient with 1 nut used
 EP₂: Mp equivalent coefficient with 2 nuts used in close contact
 Ey₁: My equivalent coefficient with 1 nut used
 Ey₂: My equivalent coefficient with 2 nuts used in close contact

Table 1-11 Slide Bush SM type unit: 1/mm

part number	equivalent coefficient	
	E ₁	E ₂
SM 3	1.24	2.13×10 ⁻¹
SM 4	1.21	1.78×10 ⁻¹
SM 5	8.96×10 ⁻¹	1.40×10 ⁻¹
SM 6	7.29×10 ⁻¹	1.09×10 ⁻¹
SM 8s	7.19×10 ⁻¹	1.20×10 ⁻¹
SM 8	5.46×10 ⁻¹	8.42×10 ⁻²
SM 10	4.55×10 ⁻¹	7.02×10 ⁻²
SM 12	4.32×10 ⁻¹	6.64×10 ⁻²
SM 13	4.06×10 ⁻¹	6.21×10 ⁻²
SM 16	3.59×10 ⁻¹	5.46×10 ⁻²
SM 20	3.07×10 ⁻¹	4.70×10 ⁻²
SM 25	2.17×10 ⁻¹	3.33×10 ⁻²
SM 30	1.99×10 ⁻¹	3.07×10 ⁻²
SM 35	1.71×10 ⁻¹	2.70×10 ⁻²
SM 40	1.64×10 ⁻¹	2.51×10 ⁻²
SM 50	1.20×10 ⁻¹	1.89×10 ⁻²
SM 60	1.13×10 ⁻¹	1.75×10 ⁻²
SM 80	8.18×10 ⁻²	1.36×10 ⁻²
SM100	6.66×10 ⁻²	1.11×10 ⁻²
SM120	5.63×10 ⁻²	9.38×10 ⁻³
SM150	4.62×10 ⁻²	7.71×10 ⁻³

E₁: equivalent coefficient with 1 bush used
 E₂: equivalent coefficient with 2 bushes used in close contact

Table 1-12 Slide Bush SM-G-L type unit: 1/mm

part number	equivalent coefficient	
	E ₁	E ₂
SM 6G-LUU	4.14×10 ⁻¹	7.39×10 ⁻²
SM 8G-LUU	3.17×10 ⁻¹	5.90×10 ⁻²
SM10G-LUU	2.53×10 ⁻¹	4.78×10 ⁻²
SM12G-LUU	2.28×10 ⁻¹	4.47×10 ⁻²
SM13G-LUU	2.03×10 ⁻¹	4.03×10 ⁻²
SM16G-LUU	1.78×10 ⁻¹	3.45×10 ⁻²
SM20G-LUU	1.53×10 ⁻¹	3.06×10 ⁻²
SM25G-LUU	1.09×10 ⁻¹	2.17×10 ⁻²
SM30G-LUU	9.59×10 ⁻²	1.97×10 ⁻²

E₁: equivalent coefficient with 1 bush used
 E₂: equivalent coefficient with 2 bushes used in close contact

Table 1-13 Slide Bush SM-W type unit : 1/mm

part number	equivalent coefficient	
	E ₁	E ₂
SM 3W	4.12 × 10 ⁻¹	—
SM 4W	4.03 × 10 ⁻¹	—
SM 5W	2.99 × 10 ⁻¹	—
SM 6W	2.43 × 10 ⁻¹	—
SM 8W	1.82 × 10 ⁻¹	—
SM 10W	1.52 × 10 ⁻¹	—
SM 12W	1.44 × 10 ⁻¹	—
SM 13W	1.35 × 10 ⁻¹	—
SM 16W	1.19 × 10 ⁻¹	—
SM 20W	1.02 × 10 ⁻¹	—
SM 25W	7.24 × 10 ⁻²	—
SM 30W	6.63 × 10 ⁻²	—
SM 35W	5.70 × 10 ⁻²	—
SM 40W	5.47 × 10 ⁻²	—
SM 50W	4.01 × 10 ⁻²	—
SM 60W	3.77 × 10 ⁻²	—

E1: equivalent coefficient with 1 bush used

Table 1-14 Slide Bush TRF type unit : 1/mm

part number	equivalent coefficient	
	E ₁	E ₂
TRF 6	6.46 × 10 ⁻²	—
TRF 8	4.90 × 10 ⁻²	—
TRF10	4.07 × 10 ⁻²	—
TRF12	3.92 × 10 ⁻²	—
TRF13	3.66 × 10 ⁻²	—
TRF16	3.20 × 10 ⁻²	—
TRF20	2.80 × 10 ⁻²	—
TRF25	2.00 × 10 ⁻²	—
TRF30	1.85 × 10 ⁻²	—
TRF35	1.68 × 10 ⁻²	—
TRF40	1.45 × 10 ⁻²	—
TRF50	1.16 × 10 ⁻²	—
TRF60	1.11 × 10 ⁻²	—

E1: equivalent coefficient with 1 bush used

Table 1-15 Slide Bush KB type unit : 1/mm

part number	equivalent coefficient	
	E ₁	E ₂
KB 3	1.28	2.13 × 10 ⁻¹
KB 4	1.05	1.75 × 10 ⁻¹
KB 5	5.40 × 10 ⁻¹	9.00 × 10 ⁻²
KB 8	5.61 × 10 ⁻¹	8.00 × 10 ⁻²
KB10	4.21 × 10 ⁻¹	7.02 × 10 ⁻²
KB12	4.02 × 10 ⁻¹	6.20 × 10 ⁻²
KB16	3.77 × 10 ⁻¹	5.73 × 10 ⁻²
KB20	3.29 × 10 ⁻¹	4.49 × 10 ⁻²
KB25	2.14 × 10 ⁻¹	3.37 × 10 ⁻²
KB30	2.08 × 10 ⁻¹	2.96 × 10 ⁻²
KB40	1.64 × 10 ⁻¹	2.51 × 10 ⁻²
KB50	1.20 × 10 ⁻¹	1.89 × 10 ⁻²
KB60	1.21 × 10 ⁻¹	1.55 × 10 ⁻²
KB80	7.34 × 10 ⁻²	1.22 × 10 ⁻²
KB 8W	1.87 × 10 ⁻¹	—
KB12W	1.34 × 10 ⁻¹	—
KB16W	1.25 × 10 ⁻¹	—
KB20W	1.10 × 10 ⁻¹	—
KB25W	7.14 × 10 ⁻²	—
KB30W	6.96 × 10 ⁻²	—
KB40W	5.47 × 10 ⁻²	—
KB50W	4.02 × 10 ⁻²	—
KB60W	4.11 × 10 ⁻²	—

E1: equivalent coefficient with 1 bush used

E2: equivalent coefficient with 2 bushes used in close contact

Table 1-16 TOPBALL TK type unit : 1/mm

part number	equivalent coefficient	
	E ₁	E ₂
TK 8	4.91 × 10 ⁻¹	8.18 × 10 ⁻²
TK10	4.17 × 10 ⁻¹	6.95 × 10 ⁻²
TK12	3.70 × 10 ⁻¹	6.17 × 10 ⁻²
TK16	3.30 × 10 ⁻¹	5.49 × 10 ⁻²
TK20	2.55 × 10 ⁻¹	4.24 × 10 ⁻²
TK25	1.90 × 10 ⁻¹	3.16 × 10 ⁻²
TK30	1.66 × 10 ⁻¹	2.76 × 10 ⁻²
TK40	1.42 × 10 ⁻¹	2.36 × 10 ⁻²
TK50	1.11 × 10 ⁻¹	1.84 × 10 ⁻²

E1: equivalent coefficient with 1 bush used

E2: equivalent coefficient with 2 bushes used in close contact

Table 1-17 TOPBALL TW type unit : 1/mm

part number	equivalent coefficient	
	E ₁	E ₂
TW 3	8.70 × 10 ⁻¹	1.45 × 10 ⁻¹
TW 4	6.57 × 10 ⁻¹	1.09 × 10 ⁻¹
TW 6	5.17 × 10 ⁻¹	8.60 × 10 ⁻²
TW 8	3.55 × 10 ⁻¹	5.90 × 10 ⁻²
TW10	3.00 × 10 ⁻¹	5.00 × 10 ⁻²
TW12	2.66 × 10 ⁻¹	4.40 × 10 ⁻²
TW16	1.90 × 10 ⁻¹	3.10 × 10 ⁻²
TW20	1.66 × 10 ⁻¹	2.70 × 10 ⁻²
TW24	1.44 × 10 ⁻¹	2.40 × 10 ⁻²
TW32	1.08 × 10 ⁻¹	1.80 × 10 ⁻²

E1: equivalent coefficient with 1 bush used

E2: equivalent coefficient with 2 bushes used in close contact

Table 1-18 Slide Bush SW type unit : 1/mm

part number	equivalent coefficient	
	E ₁	E ₂
SWS 2	8.90 × 10 ⁻¹	1.48 × 10 ⁻¹
SWS 3	8.01 × 10 ⁻¹	1.33 × 10 ⁻¹
SW 4	7.95 × 10 ⁻¹	1.05 × 10 ⁻¹
SW 6	6.98 × 10 ⁻¹	9.75 × 10 ⁻²
SW 8	4.09 × 10 ⁻¹	6.23 × 10 ⁻²
SW10	3.54 × 10 ⁻¹	5.33 × 10 ⁻²
SW12	3.10 × 10 ⁻¹	4.76 × 10 ⁻²
SW16	2.29 × 10 ⁻¹	3.40 × 10 ⁻²
SW20	1.94 × 10 ⁻¹	3.01 × 10 ⁻²
SW24	1.69 × 10 ⁻¹	2.59 × 10 ⁻²
SW32	1.19 × 10 ⁻¹	1.87 × 10 ⁻²
SW40	9.23 × 10 ⁻²	1.54 × 10 ⁻²
SW48	7.84 × 10 ⁻²	1.31 × 10 ⁻²
SW64	5.47 × 10 ⁻²	9.11 × 10 ⁻³
SW 4W	2.65 × 10 ⁻¹	—
SW 6W	2.33 × 10 ⁻¹	—
SW 8W	1.37 × 10 ⁻¹	—
SW10W	1.18 × 10 ⁻¹	—
SW12W	1.03 × 10 ⁻¹	—
SW16W	7.62 × 10 ⁻²	—
SW20W	6.47 × 10 ⁻²	—
SW24W	5.62 × 10 ⁻²	—
SW32W	3.98 × 10 ⁻²	—

E1: equivalent coefficient with 1 bush used

E2: equivalent coefficient with 2 bushes used in close contact

Table 1-19 Slide Bush GM type unit : 1/mm

part number	equivalent coefficient	
	E ₁	E ₂
GM 6	6.43 × 10 ⁻¹	1.08 × 10 ⁻¹
GM 8	4.92 × 10 ⁻¹	8.20 × 10 ⁻²
GM10	4.21 × 10 ⁻¹	7.01 × 10 ⁻²
GM12	3.85 × 10 ⁻¹	6.42 × 10 ⁻²
GM13	3.78 × 10 ⁻¹	6.29 × 10 ⁻²
GM16	3.25 × 10 ⁻¹	5.42 × 10 ⁻²
GM20	2.75 × 10 ⁻¹	4.58 × 10 ⁻²
GM25	1.98 × 10 ⁻¹	3.30 × 10 ⁻²
GM30	1.82 × 10 ⁻¹	3.03 × 10 ⁻²
GM 6W	3.54 × 10 ⁻¹	6.53 × 10 ⁻²
GM 8W	2.38 × 10 ⁻¹	4.96 × 10 ⁻²
GM10W	2.20 × 10 ⁻¹	4.50 × 10 ⁻²
GM12W	2.07 × 10 ⁻¹	3.81 × 10 ⁻²
GM13W	1.94 × 10 ⁻¹	3.76 × 10 ⁻²
GM16W	1.71 × 10 ⁻¹	3.44 × 10 ⁻²
GM20W	1.37 × 10 ⁻¹	2.69 × 10 ⁻²
GM25W	9.03 × 10 ⁻²	1.94 × 10 ⁻²
GM30W	9.55 × 10 ⁻²	1.78 × 10 ⁻²

E1: equivalent coefficient with 1 bush used

E2: equivalent coefficient with 2 bushes used in close contact

Table 1-20 Slide Rotary Bush unit : 1/mm

part number	equivalent coefficient	
	E ₁	E ₂
SRE 6	6.83 × 10 ⁻¹	1.14 × 10 ⁻¹
SRE 8	4.98 × 10 ⁻¹	8.31 × 10 ⁻²
SRE10	4.12 × 10 ⁻¹	6.86 × 10 ⁻²
SRE12	4.19 × 10 ⁻¹	6.98 × 10 ⁻²
SRE13	3.93 × 10 ⁻¹	6.54 × 10 ⁻²
SRE16	3.40 × 10 ⁻¹	5.66 × 10 ⁻²
SRE20	2.90 × 10 ⁻¹	4.84 × 10 ⁻²
SRE25	1.98 × 10 ⁻¹	3.29 × 10 ⁻²
SRE30	1.80 × 10 ⁻¹	3.01 × 10 ⁻²
SRE40	1.52 × 10 ⁻¹	2.54 × 10 ⁻²
RK12	4.32 × 10 ⁻¹	6.64 × 10 ⁻²
RK16	3.59 × 10 ⁻¹	5.46 × 10 ⁻²
RK20	3.07 × 10 ⁻¹	4.70 × 10 ⁻²
RK25	2.17 × 10 ⁻¹	3.33 × 10 ⁻²
RK30	1.99 × 10 ⁻¹	3.07 × 10 ⁻²

E1: equivalent coefficient with 1 bush used

E2: equivalent coefficient with 2 bushes used in close contact

Table 1-21 Slide Table NVT type unit : 1/mm

part number	equivalent coefficient		
	Ep	Ey	Er
NVT2035	1.51×10 ⁻¹	1.74×10 ⁻¹	1.12×10 ⁻¹
NVT2050	1.62×10 ⁻¹	1.63×10 ⁻¹	1.45×10 ⁻¹
NVT2065	1.25×10 ⁻¹	1.29×10 ⁻¹	1.32×10 ⁻¹
NVT2080	1.15×10 ⁻¹	1.14×10 ⁻¹	1.54×10 ⁻¹
NVT2095	9.51×10 ⁻²	9.56×10 ⁻²	1.43×10 ⁻¹
NVT2110	8.81×10 ⁻²	8.63×10 ⁻²	1.57×10 ⁻¹
NVT2125	8.22×10 ⁻²	7.88×10 ⁻²	1.69×10 ⁻¹
NVT2140	7.13×10 ⁻²	6.94×10 ⁻²	1.59×10 ⁻¹
NVT2155	6.48×10 ⁻²	6.26×10 ⁻²	1.69×10 ⁻¹
NVT2170	6.10×10 ⁻²	5.81×10 ⁻²	1.76×10 ⁻¹
NVT2185	5.77×10 ⁻²	5.42×10 ⁻²	1.82×10 ⁻¹
NVT3055	3.41×10 ⁻¹	2.17×10 ⁻¹	1.97×10 ⁻¹
NVT3080	9.64×10 ⁻²	1.02×10 ⁻¹	7.86×10 ⁻²
NVT3105	8.55×10 ⁻²	8.67×10 ⁻²	8.90×10 ⁻²
NVT3130	8.00×10 ⁻²	7.57×10 ⁻²	1.16×10 ⁻¹
NVT3155	5.56×10 ⁻²	5.59×10 ⁻²	8.78×10 ⁻²
NVT3180	5.12×10 ⁻²	5.08×10 ⁻²	9.25×10 ⁻²
NVT3205	4.76×10 ⁻²	4.66×10 ⁻²	9.65×10 ⁻²
NVT3230	4.45×10 ⁻²	4.31×10 ⁻²	9.99×10 ⁻²
NVT4085	1.01×10 ⁻¹	1.08×10 ⁻¹	5.63×10 ⁻²
NVT4125	9.48×10 ⁻²	8.81×10 ⁻²	8.72×10 ⁻²
NVT4165	6.01×10 ⁻²	5.97×10 ⁻²	6.56×10 ⁻²
NVT4205	4.34×10 ⁻²	4.39×10 ⁻²	6.03×10 ⁻²
NVT4245	4.06×10 ⁻²	3.97×10 ⁻²	7.11×10 ⁻²
NVT4285	3.30×10 ⁻²	3.28×10 ⁻²	6.38×10 ⁻²
NVT6110	1.74×10 ⁻¹	1.24×10 ⁻¹	1.10×10 ⁻¹
NVT6160	6.02×10 ⁻²	6.08×10 ⁻²	5.66×10 ⁻²
NVT6210	4.82×10 ⁻²	4.75×10 ⁻²	6.63×10 ⁻²
NVT6260	4.21×10 ⁻²	4.06×10 ⁻²	6.85×10 ⁻²
NVT6310	2.95×10 ⁻²	2.99×10 ⁻²	5.28×10 ⁻²
NVT6360	2.70×10 ⁻²	2.70×10 ⁻²	5.53×10 ⁻²
NVT6410	2.53×10 ⁻²	2.46×10 ⁻²	6.37×10 ⁻²
NVT9210	7.51×10 ⁻²	6.05×10 ⁻²	5.66×10 ⁻²
NVT9310	3.26×10 ⁻²	3.25×10 ⁻²	4.00×10 ⁻²
NVT9410	2.36×10 ⁻²	2.34×10 ⁻²	3.84×10 ⁻²
NVT9510	1.82×10 ⁻²	1.83×10 ⁻²	3.34×10 ⁻²

Ep: Mp equivalent coefficient Ey: My equivalent coefficient
Er: Mr equivalent coefficient

Table 1-22 Slide Table SVT type (1) unit : 1/mm

part number	equivalent coefficient		
	Ep	Ey	Er
SVT1025	2.67×10 ⁻¹	3.25×10 ⁻¹	1.48×10 ⁻¹
SVT1035	3.10×10 ⁻¹	2.73×10 ⁻¹	1.48×10 ⁻¹
SVT1045	1.71×10 ⁻¹	1.87×10 ⁻¹	1.48×10 ⁻¹
SVT1055	1.51×10 ⁻¹	1.63×10 ⁻¹	1.48×10 ⁻¹
SVT1065	1.35×10 ⁻¹	1.44×10 ⁻¹	1.48×10 ⁻¹
SVT1075	1.11×10 ⁻¹	1.17×10 ⁻¹	1.48×10 ⁻¹
SVT1085	1.02×10 ⁻¹	1.07×10 ⁻¹	1.48×10 ⁻¹
SVT2035	1.67×10 ⁻¹	2.03×10 ⁻¹	1.11×10 ⁻¹
SVT2050	1.45×10 ⁻¹	1.64×10 ⁻¹	1.11×10 ⁻¹
SVT2065	1.22×10 ⁻¹	1.37×10 ⁻¹	1.11×10 ⁻¹
SVT2080	1.28×10 ⁻¹	1.19×10 ⁻¹	1.11×10 ⁻¹
SVT2095	1.10×10 ⁻¹	1.03×10 ⁻¹	1.11×10 ⁻¹
SVT2110	7.61×10 ⁻²	8.08×10 ⁻²	1.11×10 ⁻¹
SVT2125	6.94×10 ⁻²	7.33×10 ⁻²	1.11×10 ⁻¹
SVT2140	7.01×10 ⁻²	6.73×10 ⁻²	1.11×10 ⁻¹
SVT2155	6.43×10 ⁻²	6.19×10 ⁻²	1.11×10 ⁻¹
SVT2170	5.12×10 ⁻²	5.33×10 ⁻²	1.11×10 ⁻¹
SVT2185	4.81×10 ⁻²	4.99×10 ⁻²	1.11×10 ⁻¹
SVT3055	2.00×10 ⁻¹	1.75×10 ⁻¹	7.14×10 ⁻²
SVT3080	1.22×10 ⁻¹	1.12×10 ⁻¹	7.14×10 ⁻²
SVT3105	7.53×10 ⁻²	8.14×10 ⁻²	7.14×10 ⁻²
SVT3130	6.08×10 ⁻²	6.47×10 ⁻²	7.14×10 ⁻²
SVT3155	6.17×10 ⁻²	5.89×10 ⁻²	7.14×10 ⁻²
SVT3180	5.15×10 ⁻²	4.96×10 ⁻²	7.14×10 ⁻²
SVT3205	4.75×10 ⁻²	4.59×10 ⁻²	7.14×10 ⁻²
SVT3230	3.85×10 ⁻²	3.99×10 ⁻²	7.14×10 ⁻²
SVT3255	3.87×10 ⁻²	3.76×10 ⁻²	7.14×10 ⁻²
SVT3280	3.64×10 ⁻²	3.54×10 ⁻²	7.14×10 ⁻²

Ep: Mp equivalent coefficient Ey: My equivalent coefficient
Er: Mr equivalent coefficient

Table 1-23 Slide Table SVT type (2) unit : 1/mm

part number	equivalent coefficient		
	Ep	Ey	Er
SVT3305	3.09×10 ⁻²	3.18×10 ⁻²	7.14×10 ⁻²
SVT4085	8.29×10 ⁻²	9.38×10 ⁻²	5.00×10 ⁻²
SVT4125	6.11×10 ⁻²	6.67×10 ⁻²	5.00×10 ⁻²
SVT4165	6.27×10 ⁻²	5.88×10 ⁻²	5.00×10 ⁻²
SVT4205	4.89×10 ⁻²	4.65×10 ⁻²	5.00×10 ⁻²
SVT4245	4.01×10 ⁻²	3.85×10 ⁻²	5.00×10 ⁻²
SVT4285	3.39×10 ⁻²	3.28×10 ⁻²	5.00×10 ⁻²
SVT4325	2.94×10 ⁻²	2.86×10 ⁻²	5.00×10 ⁻²
SVT4365	2.60×10 ⁻²	2.53×10 ⁻²	5.00×10 ⁻²
SVT4405	2.20×10 ⁻²	2.27×10 ⁻²	5.00×10 ⁻²
SVT6110	6.83×10 ⁻²	7.72×10 ⁻²	4.44×10 ⁻²
SVT6160	5.03×10 ⁻²	5.49×10 ⁻²	4.44×10 ⁻²
SVT6210	3.97×10 ⁻²	4.24×10 ⁻²	4.44×10 ⁻²
SVT6260	3.27×10 ⁻²	3.45×10 ⁻²	4.44×10 ⁻²
SVT6310	2.78×10 ⁻²	2.90×10 ⁻²	4.44×10 ⁻²
SVT6360	2.79×10 ⁻²	2.70×10 ⁻²	4.44×10 ⁻²
SVT6410	2.42×10 ⁻²	2.35×10 ⁻²	4.44×10 ⁻²
SVT6460	2.14×10 ⁻²	2.08×10 ⁻²	4.44×10 ⁻²
SVT6510	1.92×10 ⁻²	1.87×10 ⁻²	4.44×10 ⁻²
SVT9210	3.50×10 ⁻²	3.90×10 ⁻²	2.78×10 ⁻²
SVT9310	3.14×10 ⁻²	2.94×10 ⁻²	2.78×10 ⁻²
SVT9410	2.41×10 ⁻²	2.57×10 ⁻²	2.78×10 ⁻²
SVT9510	1.98×10 ⁻²	2.09×10 ⁻²	2.78×10 ⁻²
SVT9610	2.00×10 ⁻²	1.92×10 ⁻²	2.78×10 ⁻²
SVT9710	1.70×10 ⁻²	1.64×10 ⁻²	2.78×10 ⁻²
SVT9810	1.37×10 ⁻²	1.42×10 ⁻²	2.78×10 ⁻²
SVT9910	1.22×10 ⁻²	1.26×10 ⁻²	2.78×10 ⁻²
SVT91010	1.10×10 ⁻²	1.13×10 ⁻²	2.78×10 ⁻²

Ep: Mp equivalent coefficient Ey: My equivalent coefficient
Er: Mr equivalent coefficient

Table 1-24 Slide Table SYT type unit : 1/mm

part number	equivalent coefficient		
	Ep	Ey	Er
SYT1025	2.67×10 ⁻¹	3.25×10 ⁻¹	2.67×10 ⁻¹
SYT1035	3.10×10 ⁻¹	2.73×10 ⁻¹	2.67×10 ⁻¹
SYT1045	1.71×10 ⁻¹	1.87×10 ⁻¹	2.67×10 ⁻¹
SYT1055	1.51×10 ⁻¹	1.63×10 ⁻¹	2.67×10 ⁻¹
SYT1065	1.35×10 ⁻¹	1.44×10 ⁻¹	2.67×10 ⁻¹
SYT1075	1.11×10 ⁻¹	1.17×10 ⁻¹	2.67×10 ⁻¹
SYT1085	1.02×10 ⁻¹	1.07×10 ⁻¹	2.67×10 ⁻¹
SYT2035	1.67×10 ⁻¹	2.03×10 ⁻¹	1.54×10 ⁻¹
SYT2050	1.45×10 ⁻¹	1.64×10 ⁻¹	1.54×10 ⁻¹
SYT2065	1.22×10 ⁻¹	1.37×10 ⁻¹	1.54×10 ⁻¹
SYT2080	1.28×10 ⁻¹	1.19×10 ⁻¹	1.54×10 ⁻¹
SYT2095	1.10×10 ⁻¹	1.03×10 ⁻¹	1.54×10 ⁻¹
SYT2110	7.61×10 ⁻²	8.08×10 ⁻²	1.54×10 ⁻¹
SYT2125	6.94×10 ⁻²	7.33×10 ⁻²	1.54×10 ⁻¹
SYT3055	2.00×10 ⁻¹	1.75×10 ⁻¹	1.15×10 ⁻¹
SYT3080	1.22×10 ⁻¹	1.12×10 ⁻¹	1.15×10 ⁻¹
SYT3105	7.53×10 ⁻²	8.14×10 ⁻²	1.15×10 ⁻¹
SYT3130	6.08×10 ⁻²	6.47×10 ⁻²	1.15×10 ⁻¹
SYT3155	6.17×10 ⁻²	5.89×10 ⁻²	1.15×10 ⁻¹
SYT3180	5.15×10 ⁻²	4.96×10 ⁻²	1.15×10 ⁻¹
SYT3205	4.75×10 ⁻²	4.59×10 ⁻²	1.15×10 ⁻¹

Ep: Mp equivalent coefficient Ey: My equivalent coefficient
Er: Mr equivalent coefficient

Table 1-25 Miniature Slide SYBS type unit : 1/mm

part number	equivalent coefficient		
	Ep	Ey	Er
SYBS 6-13	8.35×10 ⁻¹	7.01×10 ⁻¹	8.51×10 ⁻¹
SYBS 6-21	5.45×10 ⁻¹	4.57×10 ⁻¹	8.51×10 ⁻¹
SYBS 8-11	8.82×10 ⁻¹	7.40×10 ⁻¹	5.88×10 ⁻¹
SYBS 8-21	4.81×10 ⁻¹	4.04×10 ⁻¹	5.88×10 ⁻¹
SYBS 8-31	3.57×10 ⁻¹	2.99×10 ⁻¹	5.88×10 ⁻¹
SYBS12-23	4.31×10 ⁻¹	3.62×10 ⁻¹	3.13×10 ⁻¹
SYBS12-31	3.57×10 ⁻¹	2.99×10 ⁻¹	3.13×10 ⁻¹
SYBS12-46	2.35×10 ⁻¹	1.97×10 ⁻¹	3.13×10 ⁻¹
SYBS17-23	4.25×10 ⁻¹	3.57×10 ⁻¹	2.67×10 ⁻¹
SYBS17-31	3.26×10 ⁻¹	2.74×10 ⁻¹	2.66×10 ⁻¹
SYBS17-46	2.23×10 ⁻¹	1.88×10 ⁻¹	2.66×10 ⁻¹

Ep: Mp equivalent coefficient Ey: My equivalent coefficient
Er: Mr equivalent coefficient

Average Applied Load

The load applied to a linear system generally varies with the travel distance depending on how the system is operated. This includes the start/stop processes of the reciprocating motion and work on the system. The average applied load is used to compute the life corresponding to the actual application conditions.

①When the load varies in a step manner with the travel distance (Figure 1-7).

- l_1 is the travel distance under load P_1
- l_2 is the travel distance under load P_2
- ⋮
- l_n is the travel distance under load P_n

The average applied load P_m is obtained by the following equation.

$$P_m = \sqrt[3]{\frac{1}{l} (P_1^3 l_1 + P_2^3 l_2 + \dots + P_n^3 l_n)} \dots (10)$$

P_m : average applied load (N) l : total travel distance (m)

②When the applied load varies linearly with the travel distance (Figure 1-8), the average applied load P_m is approximated by the following equation.

$$P_m \doteq \frac{1}{3} (P_{min} + 2P_{max}) \dots (11)$$

P_{min} : minimum applied load (N)
 P_{max} : maximum applied load (N)

③When the applied load draws a sine-curve as shown by Figures 1-9 (a) and (b), the average applied load P_m is approximated by the following equations.

Figure 1-9 (a) $P_m \doteq 0.65P_{max} \dots (12)$

Figure 1-9 (b) $P_m \doteq 0.75P_{max} \dots (13)$

Figure 1-7 Applied Load Varies Stepwise

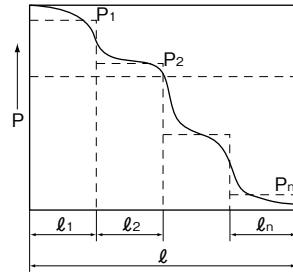

Figure 1-8 Applied Load Varies Linearly

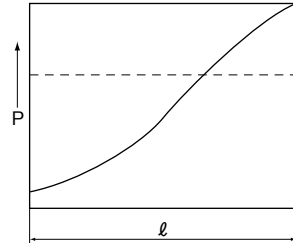
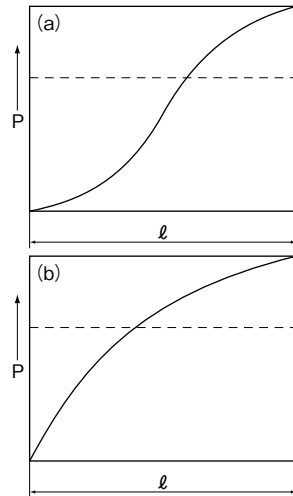

Figure 1-9 Applied Load Varies Sine-Curve



RATED LIFE CALCULATION EXAMPLE 1

2 Horizontal Axes, 2 Blocks each, Considering Acceleration/Deceleration

Operating Conditions

- part number: SGL15F/E
- basic dynamic load rating $C=7.29\text{kN}$
- basic static load rating $C_0=9.45\text{kN}$
- guide block span: $L_{unit}=100\text{mm}$
- guide rail span: $L_{rail}=100\text{mm}$
- drive: $Y_d=10\text{mm}$
- $Z_d=-10\text{mm}$
- mass: $m_1=30\text{kg}$ $X_1=15\text{mm}$
- $Y_1=-20\text{mm}$
- $Z_1=20\text{mm}$
- $m_2=15\text{kg}$ $X_2=80\text{mm}$
- $Y_2=50\text{mm}$
- $Z_2=100\text{mm}$
- velocity: $V_{max}=200\text{mm/s}$
- time: $t_1=0.2\text{s}$
- $t_2=3.3\text{s}$
- $t_3=0.2\text{s}$
- acceleration: $a_1=1.0\text{m/s}^2$
- $a_3=1.0\text{m/s}^2$
- stroke: $l_s=700\text{mm}$
- number of cycles per minute: $n_1=8\text{cpm}$

Figure 1-10

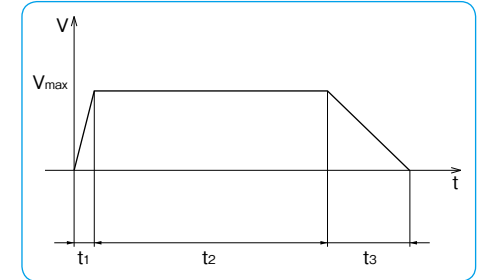
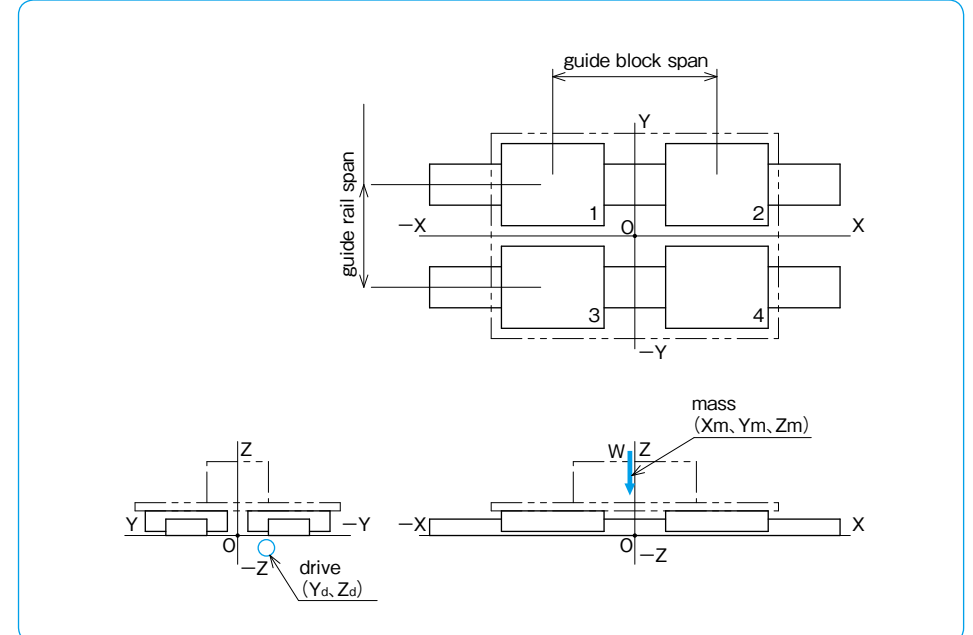

Figure 1-11



In case that some external force is applied to the system, please refer to "Slide Guide Travel Life Calculation Program" at NB website.

① Calculating Moment Applied to the Unit

<acceleration>

pitching $M_{a1} = m \cdot g \cdot X_m - m \cdot a_1 \cdot (Z_m - Z_d)$

$M_{a1} = 30 \times 9.8 \times (15) - 30 \times 1 \times \{(20) - (-10)\} + 15 \times 9.8 \times (80) - 15 \times 1 \times \{(100) - (-10)\} = 13620 \text{ N} \cdot \text{mm}$

yawing $M_{a2} = -m \cdot a_1 \cdot (Y_m - Y_d)$

$M_{a2} = -30 \times 1 \times \{(-20) - (10)\} - 15 \times 1 \times \{(50) - (10)\} = 300 \text{ N} \cdot \text{mm}$

rolling $M_{a3} = m \cdot g \cdot Y_m$

$M_{a3} = 30 \times 9.8 \times (-20) + 15 \times 9.8 \times (50) = 1470 \text{ N} \cdot \text{mm}$

<constant>

pitching $M_1 = m \cdot g \cdot X_m$

$M_1 = 30 \times 9.8 \times (15) + 15 \times 9.8 \times (80) = 16170 \text{ N} \cdot \text{mm}$

yawing $M_2 = 0$

rolling $M_3 = m \cdot g \cdot Y_m$

$M_3 = 30 \times 9.8 \times (-20) + 15 \times 9.8 \times (50) = 1470 \text{ N} \cdot \text{mm}$

<deceleration>

pitching $M_{d1} = m \cdot g \cdot X_m + m \cdot a_3 \cdot (Z_m - Z_d)$

$M_{d1} = 30 \times 9.8 \times (15) + 30 \times 1 \times \{(20) - (-10)\} + 15 \times 9.8 \times (80) + 15 \times 1 \times \{(100) - (-10)\} = 18720 \text{ N} \cdot \text{mm}$

yawing $M_{d2} = m \cdot a_3 \cdot (Y_m - Y_d)$

$M_{d2} = 30 \times 1 \times \{(-20) - (10)\} + 15 \times 1 \times \{(50) - (10)\} = -300 \text{ N} \cdot \text{mm}$

rolling $M_{d3} = m \cdot g \cdot Y_m$

$M_{d3} = 30 \times 9.8 \times (-20) + 15 \times 9.8 \times (50) = 1470 \text{ N} \cdot \text{mm}$

② Calculating Load Applied to the Guide Block

<acceleration>

Block 1

vertical direction $F_{ra1} = \frac{m \cdot g}{4} - \frac{M_{a1}}{2 \cdot L_{unit}} + \frac{M_{a3}}{2 \cdot L_{rail}}$

$F_{ra1} = \frac{30 \times 9.8}{4} + \frac{15 \times 9.8}{4} - \frac{13620}{2 \times 100} + \frac{1470}{2 \times 100} = 49.5 \text{ N}$

horizontal direction $F_{sa1} = \frac{M_{a2}}{2 \cdot L_{unit}}$

$F_{sa1} = \frac{300}{2 \times 100} = 1.5 \text{ N}$

Block 2

vertical direction $F_{ra2} = \frac{m \cdot g}{4} + \frac{M_{a1}}{2 \cdot L_{unit}} + \frac{M_{a3}}{2 \cdot L_{rail}}$

$F_{ra2} = \frac{30 \times 9.8}{4} + \frac{15 \times 9.8}{4} + \frac{13620}{2 \times 100} + \frac{1470}{2 \times 100} = 185.7 \text{ N}$

horizontal direction $F_{sa2} = -\frac{M_{a2}}{2 \cdot L_{unit}}$

$F_{sa2} = -\frac{300}{2 \times 100} = -1.5 \text{ N}$

Block 3

vertical direction $F_{ra3} = \frac{m \cdot g}{4} - \frac{M_{a1}}{2 \cdot L_{unit}} - \frac{M_{a3}}{2 \cdot L_{rail}}$

$F_{ra3} = \frac{30 \times 9.8}{4} + \frac{15 \times 9.8}{4} - \frac{13620}{2 \times 100} - \frac{1470}{2 \times 100} = 34.8 \text{ N}$

horizontal direction $F_{sa3} = \frac{M_{a2}}{2 \cdot L_{unit}}$

$F_{sa3} = \frac{300}{2 \times 100} = 1.5 \text{ N}$

Block 4

vertical direction $F_{ra4} = \frac{m \cdot g}{4} + \frac{M_{a1}}{2 \cdot L_{unit}} - \frac{M_{a3}}{2 \cdot L_{rail}}$

$F_{ra4} = \frac{30 \times 9.8}{4} + \frac{15 \times 9.8}{4} + \frac{13620}{2 \times 100} - \frac{1470}{2 \times 100} = 171.0 \text{ N}$

horizontal direction $F_{sa4} = -\frac{M_{a2}}{2 \cdot L_{unit}}$

$F_{sa4} = -\frac{300}{2 \times 100} = -1.5 \text{ N}$

<constant>

Block 1

vertical direction $F_{r1} = \frac{m \cdot g}{4} - \frac{M_1}{2 \cdot L_{unit}} + \frac{M_3}{2 \cdot L_{rail}}$

$F_{r1} = \frac{30 \times 9.8}{4} + \frac{15 \times 9.8}{4} - \frac{16170}{2 \times 100} + \frac{1470}{2 \times 100} = 36.8 \text{ N}$

horizontal direction $F_{s1} = \frac{M_2}{2 \cdot L_{unit}}$

Block 2

vertical direction $F_{r2} = \frac{m \cdot g}{4} + \frac{M_1}{2 \cdot L_{unit}} + \frac{M_3}{2 \cdot L_{rail}}$

$F_{r2} = \frac{30 \times 9.8}{4} + \frac{15 \times 9.8}{4} + \frac{16170}{2 \times 100} + \frac{1470}{2 \times 100} = 198.5 \text{ N}$

horizontal direction $F_{s2} = -\frac{M_2}{2 \cdot L_{unit}}$

Block 3

vertical direction $F_{r3} = \frac{m \cdot g}{4} - \frac{M_1}{2 \cdot L_{unit}} - \frac{M_3}{2 \cdot L_{rail}}$

$F_{r3} = \frac{30 \times 9.8}{4} + \frac{15 \times 9.8}{4} - \frac{16170}{2 \times 100} - \frac{1470}{2 \times 100} = 22.1 \text{ N}$

horizontal direction $F_{s3} = \frac{M_2}{2 \cdot L_{unit}}$

Block 4

vertical direction $F_{r4} = \frac{m \cdot g}{4} + \frac{M_1}{2 \cdot L_{unit}} - \frac{M_3}{2 \cdot L_{rail}}$

$F_{r4} = \frac{30 \times 9.8}{4} + \frac{15 \times 9.8}{4} + \frac{16170}{2 \times 100} - \frac{1470}{2 \times 100} = 183.8 \text{ N}$

horizontal direction $F_{s4} = -\frac{M_2}{2 \cdot L_{unit}}$

(deceleration)

Block 1

vertical direction
$$Frd_1 = \frac{m \cdot g}{4} - \frac{Md_1}{2 \cdot L_{unit}} + \frac{Md_3}{2 \cdot L_{rail}}$$

$$Frd_1 = \frac{30 \times 9.8}{4} + \frac{15 \times 9.8}{4} - \frac{18720}{2 \times 100} + \frac{1470}{2 \times 100} = 24.0N$$

horizontal direction
$$Fsd_1 = \frac{Md_2}{2 \cdot L_{unit}}$$

$$Fsd_1 = \frac{-300}{2 \times 100} = -1.5N$$

Block 2

vertical direction
$$Frd_2 = \frac{m \cdot g}{4} + \frac{Md_1}{2 \cdot L_{unit}} + \frac{Md_3}{2 \cdot L_{rail}}$$

$$Frd_2 = \frac{30 \times 9.8}{4} + \frac{15 \times 9.8}{4} + \frac{18720}{2 \times 100} + \frac{1470}{2 \times 100} = 211.2N$$

horizontal direction
$$Fsd_2 = -\frac{Md_2}{2 \cdot L_{unit}}$$

$$Fsd_2 = -\frac{-300}{2 \times 100} = 1.5N$$

Block 3

vertical direction
$$Frd_3 = \frac{m \cdot g}{4} - \frac{Md_1}{2 \cdot L_{unit}} - \frac{Md_3}{2 \cdot L_{rail}}$$

$$Frd_3 = \frac{30 \times 9.8}{4} + \frac{15 \times 9.8}{4} - \frac{18720}{2 \times 100} - \frac{1470}{2 \times 100} = 9.3N$$

horizontal direction
$$Fsd_3 = \frac{Md_2}{2 \cdot L_{unit}}$$

$$Fsd_3 = \frac{-300}{2 \times 100} = -1.5N$$

Block 4

vertical direction
$$Frd_4 = \frac{m \cdot g}{4} + \frac{Md_1}{2 \cdot L_{unit}} - \frac{Md_3}{2 \cdot L_{rail}}$$

$$Frd_4 = \frac{30 \times 9.8}{4} + \frac{15 \times 9.8}{4} + \frac{18720}{2 \times 100} - \frac{1470}{2 \times 100} = 196.5N$$

horizontal direction
$$Fsd_4 = -\frac{Md_2}{2 \cdot L_{unit}}$$

$$Fsd_4 = -\frac{-300}{2 \times 100} = 1.5N$$

③ Calculating Equivalent Load

©Pr in the vertical direction and Ps in the horizontal direction are calculated by the following equations.

$$Pr = |Fr|$$

$$Ps = |k \cdot Fs|$$

k=1 for SGL guide

Table 1-26

	acceleration	constant	deceleration
block 1	Pra ₁ =49.5	Pr ₁ =36.8	Prd ₁ =24.0
	Ps _{a1} =1.5	Ps ₁ =0	Ps _{d1} =1.5
block 2	Pra ₂ =185.7	Pr ₂ =198.5	Prd ₂ =211.2
	Ps _{a2} =1.5	Ps ₂ =0	Ps _{d2} =1.5
block 3	Pra ₃ =34.8	Pr ₃ =22.1	Prd ₃ =9.3
	Ps _{a3} =1.5	Ps ₃ =0	Ps _{d3} =1.5
block 4	Pra ₄ =171.0	Pr ₄ =183.8	Prd ₄ =196.5
	Ps _{a4} =1.5	Ps ₄ =0	Ps _{d4} =1.5

©Equation for Dynamic Equivalent Load

$$P = Pr + Ps$$

Pa₁=Pra₁+Ps_{a1}=49.5+1.5=51.0 (N)
calculating in the same manner

Table 1-27

	acceleration	constant	deceleration
block 1	Pa ₁ =51.0	P ₁ =36.8	Pd ₁ =25.5
block 2	Pa ₂ =187.2	P ₂ =198.5	Pd ₂ =212.7
block 3	Pa ₃ =36.3	P ₃ =22.1	Pd ₃ =10.8
block 4	Pa ₄ =172.5	P ₄ =183.8	Pd ₄ =198.0

©Calculating Average Equivalent Load

$$Pm = \sqrt[3]{\frac{1}{L_s} \times \left\{ (Pa^3 \times \frac{V_{max} \times t_1}{2}) + (P^3 \times V_{max} \times t_2) + (Pd^3 \times \frac{V_{max} \times t_3}{2}) \right\}}$$

$$Pm_1 = \sqrt[3]{\frac{1}{700} \times \left\{ (51.0^3 \times \frac{200 \times 0.2}{2}) + (36.8^3 \times 200 \times 3.3) + (25.5^3 \times \frac{200 \times 0.2}{2}) \right\}} = 37.1(N)$$

$$Pm_2 = \sqrt[3]{\frac{1}{700} \times \left\{ (187.2^3 \times \frac{200 \times 0.2}{2}) + (198.5^3 \times 200 \times 3.3) + (212.7^3 \times \frac{200 \times 0.2}{2}) \right\}} = 198.6(N)$$

$$Pm_3 = \sqrt[3]{\frac{1}{700} \times \left\{ (36.3^3 \times \frac{200 \times 0.2}{2}) + (22.1^3 \times 200 \times 3.3) + (10.8^3 \times \frac{200 \times 0.2}{2}) \right\}} = 22.6(N)$$

$$Pm_4 = \sqrt[3]{\frac{1}{700} \times \left\{ (172.5^3 \times \frac{200 \times 0.2}{2}) + (183.8^3 \times 200 \times 3.3) + (198.0^3 \times \frac{200 \times 0.2}{2}) \right\}} = 183.9(N)$$

④ Calculating Rated Life

Decide each coefficient

f_H: hardness coefficient f_H=1 for hardness of guide is 58HRC or more

f_T: temperature coefficient f_T=1 operating temperature is below 100°C (80°C is maximum for SGL guide)

f_C: contact coefficient f_C=1 for blocks are not in close contact

f_w: applied load coefficient f_w=1.5 for V_{max}=200mm/s

©Calculating Rated Life

Selecting Block 2 that carries the maximum dynamic equivalent load

$$L = \left(\frac{f_H \times f_T \times f_C}{f_w} \times \frac{C}{P_m} \right)^3 \times 50$$

$$L = \left(\frac{1 \times 1 \times 1}{1.5} \times \frac{7290}{198.6} \right)^3 \times 50 = 732725(km)$$

©Calculating Life Time

$$L_h = \frac{L \times 10^3}{2 \times l_s \times n_1 \times 60}$$

$$L_h = \frac{732725 \times 10^3}{2 \times 0.7 \times 8 \times 60} = 1090364(\text{hour})$$

⑤ Calculating Static Safety Factor

◎ Equation for Static Equivalent Load

$$P_o = P_r + P_s$$

$P_{oa1} = P_{ra1} + P_{sa1} = 49.5 + 1.5 = 51.0$ (N)
calculating in the same manner

Table 1-28

	acceleration	constant	deceleration
block 1	$P_{oa1} = 51.0$	$P_{o1} = 36.8$	$P_{od1} = 25.5$
block 2	$P_{oa2} = 187.2$	$P_{o2} = 198.5$	$P_{od2} = 212.7$
block 3	$P_{oa3} = 36.3$	$P_{o3} = 22.1$	$P_{od3} = 10.8$
block 4	$P_{oa4} = 172.5$	$P_{o4} = 183.8$	$P_{od4} = 198.0$

Selecting Block 2 that carries the maximum static equivalent load

$$f_s = \frac{C_o}{P_o}$$

$$f_s = \frac{C_o}{P_{od2}} = \frac{9450}{212.7} = 44$$

RATED LIFE CALCULATION EXAMPLE 2

1 Horizontal Axis, 2 Blocks, Considering Acceleration/Deceleration

Operating Conditions

part number: SEB9A

basic dynamic load rating $C = 1.92\text{kN}$

basic static load rating $C_o = 2.53\text{kN}$

guide block span: $L_{unit} = 70\text{mm}$

drive: $Y_d = 30\text{mm}$

$Z_d = -10\text{mm}$

mass: $m_1 = 5\text{kg}$ $X_1 = 0\text{mm}$

$Y_1 = 0\text{mm}$

$Z_1 = 10\text{mm}$

$m_2 = 20\text{kg}$ $X_2 = -20\text{mm}$

$Y_2 = -10\text{mm}$

$Z_2 = 20\text{mm}$

velocity: $V_{max} = 150\text{mm/s}$

time: $t_1 = 0.1\text{s}$

$t_2 = 1.9\text{s}$

$t_3 = 0.1\text{s}$

acceleration: $a_1 = 1.5\text{m/s}^2$

$a_3 = 1.5\text{m/s}^2$

stroke: $l_s = 300\text{mm}$

number of cycles per minute: $n_1 = 14\text{cpm}$

Figure 1-12

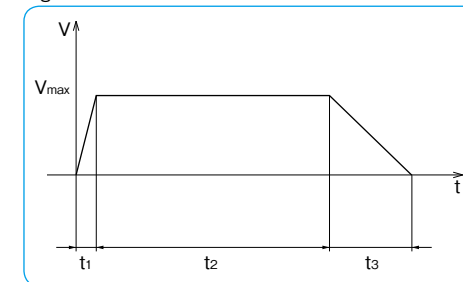
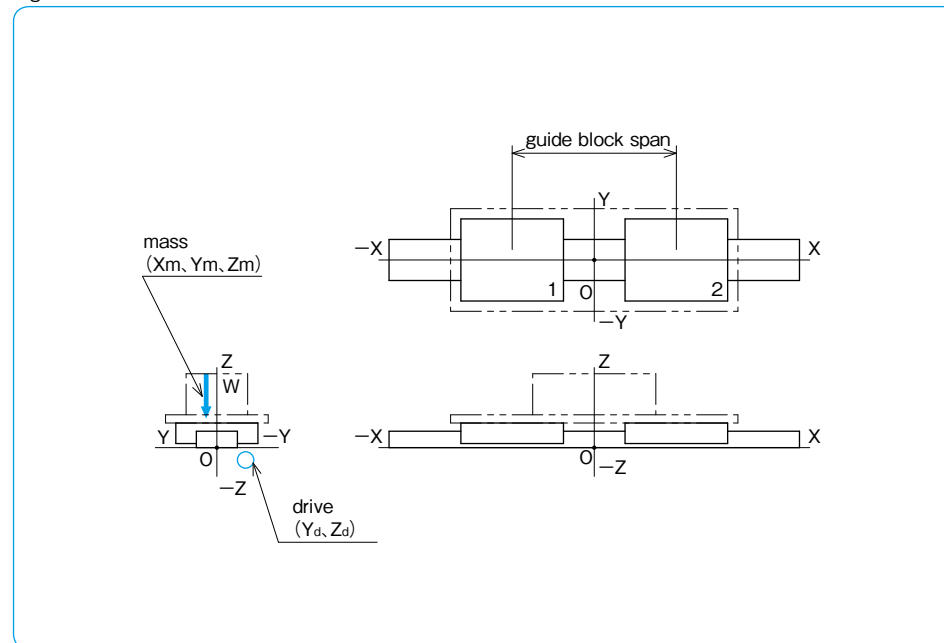

Figure 1-13



① Calculating Moment Applied to the Unit

<acceleration>

pitching $Ma_1 = m \cdot g \cdot Xm - m \cdot a_1 \cdot (Zm - Zd)$

$$Ma_1 = 5 \times 9.8 \times (0) - 5 \times 1.5 \times \{(10) - (-10)\} + 20 \times 9.8 \times (-20) - 20 \times 1.5 \times \{(20) - (-10)\} = -4970 \text{ N} \cdot \text{mm}$$

yawing $Ma_2 = -m \cdot a_1 \cdot (Ym - Yd)$

$$Ma_2 = -5 \times 1.5 \times \{(0) - (-30)\} - 20 \times 1.5 \times \{(-10) - (-30)\} = -825 \text{ N} \cdot \text{mm}$$

rolling $Ma_3 = m \cdot g \cdot Ym$

$$Ma_3 = 5 \times 9.8 \times (0) + 20 \times 9.8 \times (-10) = -1960 \text{ N} \cdot \text{mm}$$

<constant>

pitching $M_1 = m \cdot g \cdot Xm$

$$M_1 = 5 \times 9.8 \times (0) + 20 \times 9.8 \times (-20) = -3920 \text{ N} \cdot \text{mm}$$

yawing $M_2 = 0$

$$M_2 = 0 \text{ N} \cdot \text{mm}$$

rolling $M_3 = m \cdot g \cdot Ym$

$$M_3 = 5 \times 9.8 \times (0) + 20 \times 9.8 \times (-10) = -1960 \text{ N} \cdot \text{mm}$$

<deceleration>

pitching $Md_1 = m \cdot g \cdot Xm + m \cdot a_3 \cdot (Zm - Zd)$

$$Md_1 = 5 \times 9.8 \times (0) + 5 \times 1.5 \times \{(10) - (-10)\} + 20 \times 9.8 \times (-20) + 20 \times 1.5 \times \{(20) - (-10)\} = -2870 \text{ N} \cdot \text{mm}$$

yawing $Md_2 = m \cdot a_3 \cdot (Ym - Yd)$

$$Md_2 = 5 \times 1.5 \times \{(0) - (-30)\} + 20 \times 1.5 \times \{(-10) - (-30)\} = 825 \text{ N} \cdot \text{mm}$$

rolling $Md_3 = m \cdot g \cdot Ym$

$$Md_3 = 5 \times 9.8 \times (0) + 20 \times 9.8 \times (-10) = -1960 \text{ N} \cdot \text{mm}$$

② Calculating Load Applied to the Guide Block

<acceleration>

Block 1

vertical direction $Fra_1 = \frac{m \cdot g}{2} - \frac{Ma_1}{L_{\text{unit}}}$

$$Fra_1 = \frac{5 \times 9.8}{2} + \frac{20 \times 9.8}{2} - \frac{-4970}{70} = 193.5 \text{ N}$$

horizontal direction $Fsa_1 = \frac{Ma_2}{L_{\text{unit}}}$

$$Fsa_1 = \frac{-825}{70} = -11.8 \text{ N}$$

rolling moment $Mra_1 = \frac{Ma_3}{2}$

$$Mra_1 = \frac{-1960}{2} = -980 \text{ N} \cdot \text{mm}$$

Block 2

vertical direction $Fra_2 = \frac{m \cdot g}{2} + \frac{Ma_1}{L_{\text{unit}}}$

$$Fra_2 = \frac{5 \times 9.8}{2} + \frac{20 \times 9.8}{2} + \frac{-4970}{70} = 51.5 \text{ N}$$

horizontal direction $Fsa_2 = \frac{Ma_2}{L_{\text{unit}}}$

$$Fsa_2 = \frac{-825}{70} = -11.8 \text{ N}$$

rolling moment $Mra_2 = \frac{Ma_3}{2}$

$$Mra_2 = \frac{-1960}{2} = -980 \text{ N} \cdot \text{mm}$$

<constant>

Block 1

vertical direction $Fr_1 = \frac{m \cdot g}{2} - \frac{M_1}{L_{\text{unit}}}$

$$Fr_1 = \frac{5 \times 9.8}{2} + \frac{20 \times 9.8}{2} - \frac{-3920}{70} = 178.5 \text{ N}$$

horizontal direction $Fs_1 = \frac{M_2}{L_{\text{unit}}}$

rolling moment $Mr_1 = \frac{M_3}{2}$

$$Mr_1 = \frac{-1960}{2} = -980 \text{ N} \cdot \text{mm}$$

Block 2

vertical direction $Fr_2 = \frac{m \cdot g}{2} + \frac{M_1}{L_{\text{unit}}}$

$$Fr_2 = \frac{5 \times 9.8}{2} + \frac{20 \times 9.8}{2} + \frac{-3920}{70} = 66.5 \text{ N}$$

horizontal direction $Fs_2 = -\frac{M_2}{L_{\text{unit}}}$

rolling moment $Mr_2 = \frac{M_3}{2}$

$$Mr_2 = \frac{-1960}{2} = -980 \text{ N} \cdot \text{mm}$$

<deceleration>

Block 1

vertical direction $Frd_1 = \frac{m \cdot g}{2} - \frac{Md_1}{L_{unit}}$

$$Frd_1 = \frac{5 \times 9.8}{2} + \frac{20 \times 9.8}{2} - \frac{-2870}{70} = 163.5 \text{ N}$$

horizontal direction $Fsd_1 = \frac{Md_2}{L_{unit}}$

$$Fsd_1 = \frac{825}{70} = 11.8 \text{ N}$$

rolling moment $Mrd_1 = \frac{Md_3}{2}$

$$Mrd_1 = \frac{-1960}{2} = -980 \text{ N} \cdot \text{mm}$$

Block 2

vertical direction $Frd_2 = \frac{m \cdot g}{2} + \frac{Md_1}{L_{unit}}$

$$Frd_2 = \frac{5 \times 9.8}{2} + \frac{20 \times 9.8}{2} + \frac{-2870}{70} = 81.5 \text{ N}$$

horizontal direction $Fsd_2 = -\frac{Md_2}{L_{unit}}$

$$Fsd_2 = -\frac{825}{70} = -11.8 \text{ N}$$

rolling moment $Mrd_2 = \frac{Md_3}{2}$

$$Mrd_2 = \frac{-1960}{2} = -980 \text{ N} \cdot \text{mm}$$

③ Calculating Equivalent Load

◎Pr in the vertical direction and Ps in the horizontal direction are calculated by the following equations.

$$Pr = |Fr| + |Er \cdot Mr|$$

$$Ps = |k \cdot Fs|$$

Er=0.220 for SEB9A
k=0.84 for SEB-A guide

Pr_{a1} = |Fr_{a1}| + |Er · Mr_{a1}| = |193.5| + |0.220 × (-980)| = 409.1 (N)
calculating in the same manner

Table 1-29

	acceleration	constant	deceleration
block 1	Pr _{a1} =409.1	Pr ₁ =394.1	Pr _{d1} =379.1
	Ps _{a1} =9.9	Ps ₁ =0	Ps _{d1} =9.9
block 2	Pr _{a2} =267.1	Pr ₂ =282.1	Pr _{d2} =297.1
	Ps _{a2} =9.9	Ps ₂ =0	Ps _{d2} =9.9

◎Equation for Dynamic Equivalent Load

$$P = Pr + Ps$$

Pa₁ = Pr_{a1} + Ps_{a1} = 409.1 + 9.9 = 419.0 (N)
calculating in the same manner

Table 1-30

	acceleration	constant	deceleration
block 1	Pa ₁ =419.0	P ₁ =394.1	Pd ₁ =389.0
block 2	Pa ₂ =277.0	P ₂ =282.1	Pd ₂ =307.0

◎Calculating Average Equivalent Load

$$Pm = \sqrt[3]{\frac{1}{Ls} \times \left\{ (Pa^3 \times \frac{V_{max} \times t_1}{2}) + (P^3 \times V_{max} \times t_2) + (Pd^3 \times \frac{V_{max} \times t_3}{2}) \right\}}$$

$$Pm_1 = \sqrt[3]{\frac{1}{300} \times \left\{ (419.0^3 \times \frac{150 \times 0.1}{2}) + (394.1^3 \times 150 \times 1.9) + (389.0^3 \times \frac{150 \times 0.1}{2}) \right\}} = 394.6 \text{ (N)}$$

$$Pm_2 = \sqrt[3]{\frac{1}{300} \times \left\{ (277.0^3 \times \frac{150 \times 0.1}{2}) + (282.1^3 \times 150 \times 1.9) + (307.0^3 \times \frac{150 \times 0.1}{2}) \right\}} = 282.7 \text{ (N)}$$

④ Calculating Rated Life

Decide each coefficient

f_H : hardness coefficient $f_H=1$ for hardness of guide is 58HRC or more

f_T : temperature coefficient $f_T=1$ operating temperature is below 100°C (80°C is maximum for SEB-A guide)

f_C : contact coefficient $f_C=1$ for blocks are not in close contact

f_W : applied load coefficient $f_W=1.5$ for $V_{max}=150\text{mm/s}$

◎ Calculating Rated Life

Selecting Block 1 that carries the maximum dynamic equivalent load

$$L = \left(\frac{f_H \times f_T \times f_C}{f_W} \times \frac{C}{P_m} \right)^3 \times 50$$

$$L = \left(\frac{1 \times 1 \times 1}{1.5} \times \frac{1920}{394.6} \right)^3 \times 50 = 1706(\text{km})$$

◎ Calculating Life Time

$$L_h = \frac{L \times 10^3}{2 \times l_s \times n_1 \times 60}$$

$$L_h = \frac{1706 \times 10^3}{2 \times 0.3 \times 14 \times 60} = 3384(\text{hour})$$

⑤ Calculating Static Safety Factor

◎ Equation for Static Equivalent Load

$$P_o = P_r + P_s$$

$$P_{oa1} = P_{ra1} + P_{sa1} = 409.1 + 9.9 = 419.0 (\text{N})$$

calculating in the same manner

Table 1-31

	acceleration	constant	deceleration
block 1	$P_{oa1} = 419.0$	$P_{o1} = 394.1$	$P_{od1} = 389.0$
block 2	$P_{oa2} = 277.0$	$P_{o2} = 282.1$	$P_{od2} = 307.0$

Selecting Block 1 that carries the maximum static equivalent load

$$f_s = \frac{C_o}{P_o}$$

$$f_s = \frac{C_o}{P_{oa1}} = \frac{2530}{419.0} = 6.0$$

RATED LIFE CALCULATION EXAMPLE 3

2 Vertical Axes, 1 Bush each, Considering Acceleration/Deceleration

Operating Conditions

part number: SM30W

basic dynamic load rating $C = 2.49\text{kN}$

basic static load rating $C_o = 5.49\text{kN}$

shaft span: $L_{rail} = 80\text{mm}$

drive: $Y_d = 20\text{mm}$

$Z_d = -20\text{mm}$

mass: $m_1 = 5\text{kg}$ $X_1 = 0\text{mm}$

$Y_1 = 0\text{mm}$

$Z_1 = 30\text{mm}$

$m_2 = 20\text{kg}$ $X_2 = 40\text{mm}$

$Y_2 = 50\text{mm}$

$Z_2 = 20\text{mm}$

velocity: $V_{max} = 150\text{mm/s}$

time: $t_1 = 0.1\text{s}$

$t_2 = 0.7\text{s}$

$t_3 = 0.1\text{s}$

acceleration: $a_1 = 1.5\text{m/s}^2$

$a_3 = 1.5\text{m/s}^2$

stroke: $l_s = 120\text{mm}$

number of cycles per minute: $n_1 = 33\text{cpm}$

Figure 1-14

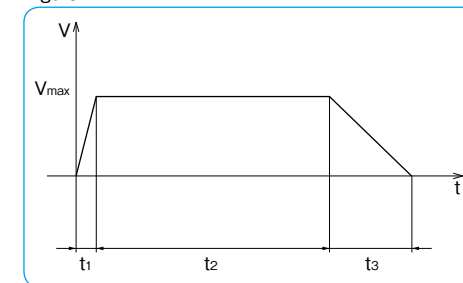
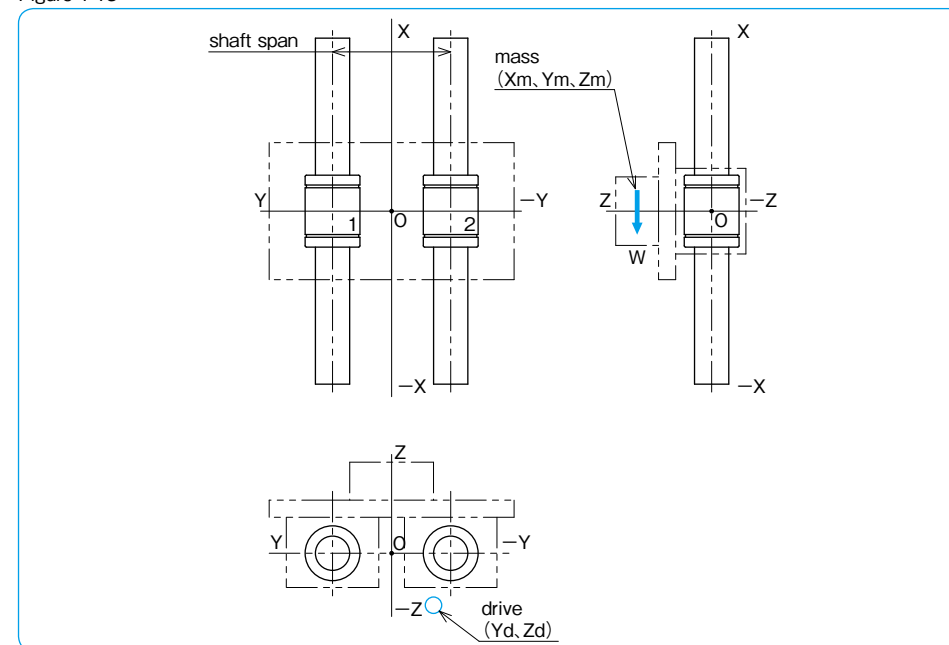

Figure 1-15



① Calculating Moment Applied to the Unit

<acceleration>

pitching $M_{a1} = m \cdot g \cdot (Z_m - Z_d) + m \cdot a_1 \cdot (Z_m - Z_d)$

$M_{a1} = 5 \times 9.8 \times \{(30) - (-20)\} + 5 \times 1.5 \times \{(30) - (-20)\} + 20 \times 9.8 \times \{(20) - (-20)\} + 20 \times 1.5 \times \{(20) - (-20)\} = 11865 \text{ N} \cdot \text{mm}$

yawing $M_{a2} = m \cdot g \cdot (Y_m - Y_d) + m \cdot a_1 \cdot (Y_m - Y_d)$

$M_{a2} = 5 \times 9.8 \times \{(0) - (20)\} + 5 \times 1.5 \times \{(0) - (20)\} + 20 \times 9.8 \times \{(50) - (20)\} + 20 \times 1.5 \times \{(50) - (20)\} = 5650 \text{ N} \cdot \text{mm}$

rolling $M_{a3} = 0$

<constant>

pitching $M_1 = m \cdot g \cdot (Z_m - Z_d)$

$M_1 = 5 \times 9.8 \times \{(30) - (-20)\} + 20 \times 9.8 \times \{(20) - (-20)\} = 10290 \text{ N} \cdot \text{mm}$

yawing $M_2 = m \cdot g \cdot (Y_m - Y_d)$

$M_2 = 5 \times 9.8 \times \{(0) - (20)\} + 20 \times 9.8 \times \{(50) - (20)\} = 4900 \text{ N} \cdot \text{mm}$

rolling $M_3 = 0$

<deceleration>

pitching $M_{d1} = m \cdot g \cdot (Z_m - Z_d) - m \cdot a_3 \cdot (Z_m - Z_d)$

$M_{d1} = 5 \times 9.8 \times \{(30) - (-20)\} - 5 \times 1.5 \times \{(30) - (-20)\} + 20 \times 9.8 \times \{(20) - (-20)\} - 20 \times 1.5 \times \{(20) - (-20)\} = 8715 \text{ N} \cdot \text{mm}$

yawing $M_{d2} = m \cdot g \cdot (Y_m - Y_d) - m \cdot a_3 \cdot (Y_m - Y_d)$

$M_{d2} = 5 \times 9.8 \times \{(0) - (20)\} - 5 \times 1.5 \times \{(0) - (20)\} + 20 \times 9.8 \times \{(50) - (20)\} - 20 \times 1.5 \times \{(50) - (20)\} = 4150 \text{ N} \cdot \text{mm}$

rolling $M_{d3} = 0$

② Calculating Load Applied to the Slide Bush

<acceleration>

Bush 1 vertical direction $F_{ra1} = \frac{M_{a3}}{L_{rail}} = 0$

horizontal direction $F_{sa1} = 0$

pitching $M_{pa1} = \frac{M_{a1}}{2}$

$M_{pa1} = \frac{11865}{2} = 5932.5 \text{ N} \cdot \text{mm}$

yawing $M_{ya1} = \frac{M_{a2}}{2}$

$M_{ya1} = \frac{5650}{2} = 2825 \text{ N} \cdot \text{mm}$

Bush 2

vertical direction $F_{ra2} = \frac{M_{a3}}{2 \cdot L_{rail}} = 0$

horizontal direction $F_{sa2} = 0$

pitching $M_{pa2} = \frac{M_{a1}}{2}$

$M_{pa2} = \frac{11865}{2} = 5932.5 \text{ N} \cdot \text{mm}$

yawing $M_{ya2} = \frac{M_{a2}}{2}$

$M_{ya2} = \frac{5650}{2} = 2825 \text{ N} \cdot \text{mm}$

<constant>

Bush 1 vertical direction $F_{r1} = \frac{M_3}{L_{rail}} = 0$

horizontal direction $F_{s1} = 0$

pitching $M_{p1} = \frac{M_1}{2}$

$M_{p1} = \frac{10290}{2} = 5145 \text{ N} \cdot \text{mm}$

yawing $M_{y1} = \frac{M_2}{2}$

$M_{y1} = \frac{4900}{2} = 2450 \text{ N} \cdot \text{mm}$

Bush 2

vertical direction $F_{r2} = \frac{M_3}{L_{rail}} = 0$

horizontal direction $F_{s2} = 0$

pitching $M_{p2} = \frac{M_1}{2}$

$M_{p2} = \frac{10290}{2} = 5145 \text{ N} \cdot \text{mm}$

yawing $M_{y2} = \frac{M_2}{2}$

$M_{y2} = \frac{4900}{2} = 2450 \text{ N} \cdot \text{mm}$

<deceleration>

Bush 1

vertical direction $Frd_1 = \frac{Md_3}{L_{rail}} = 0$

horizontal direction $Fsd_1 = 0$

pitching $Mpd_1 = \frac{Md_1}{2}$
 $Mpd_1 = \frac{8715}{2} = 4357.5N \cdot mm$

yawing $Myd_1 = \frac{Md_2}{2}$
 $Myd_1 = \frac{4150}{2} = 2075N \cdot mm$

Bush 2

vertical direction $Frd_2 = \frac{Md_3}{L_{rail}} = 0$

horizontal direction $Fsd_2 = 0$

pitching $Mpd_2 = \frac{Md_1}{2}$
 $Mpd_2 = \frac{8715}{2} = 4357.5N \cdot mm$

yawing $Myd_2 = \frac{Md_2}{2}$
 $Myd_2 = \frac{4150}{2} = 2075N \cdot mm$

③ Calculating Equivalent Load

◎Pr in the vertical direction and Ps in the horizontal direction are calculated by the following equations.

$$Pr = |Fr| + |E_1 \cdot Mp|$$

$$Ps = |k \cdot Fs| + |E_1 \cdot My|$$

$E_1 = 6.63 \times 10^{-2}$ for SM30W
 $k=1$ for Slide Bush

Table 1-32

	acceleration	constant	deceleration
bush 1	$Pr_1 = 393.3$	$Pr_1 = 341.1$	$Prd_1 = 288.9$
	$Ps_1 = 187.3$	$Ps_1 = 162.4$	$Ps_1 = 137.6$
bush 2	$Pr_2 = 393.3$	$Pr_2 = 341.1$	$Prd_2 = 288.9$
	$Ps_2 = 187.3$	$Ps_2 = 162.4$	$Ps_2 = 137.6$

◎Equation for Dynamic Equivalent Load

$$P = Pr + Ps$$

$Pa_1 = Pr_1 + Ps_1 = 393.3 + 187.3 = 580.6(N)$
 calculating in the same manner

Table 1-33

	acceleration	constant	deceleration
bush 1	$Pa_1 = 580.6$	$P_1 = 503.5$	$Pd_1 = 426.5$
bush 2	$Pa_2 = 580.6$	$P_2 = 503.5$	$Pd_2 = 426.5$

◎Calculating Average Equivalent Load

$$Pm = \sqrt[3]{\frac{1}{L_s} \times \left\{ (Pa^3 \times \frac{V_{max} \times t_1}{2}) + (P^3 \times V_{max} \times t_2) + (Pd^3 \times \frac{V_{max} \times t_3}{2}) \right\}}$$

$$Pm_1 = \sqrt[3]{\frac{1}{120} \times \left\{ (580.6^3 \times \frac{150 \times 0.1}{2}) + (503.5^3 \times 150 \times 0.7) + (426.5^3 \times \frac{150 \times 0.1}{2}) \right\}} = 505.0(N)$$

$$Pm_2 = \sqrt[3]{\frac{1}{120} \times \left\{ (580.6^3 \times \frac{150 \times 0.1}{2}) + (503.5^3 \times 150 \times 0.7) + (426.5^3 \times \frac{150 \times 0.1}{2}) \right\}} = 505.0(N)$$

④ Calculating Rated Life

Decide each coefficient

- f_H : hardness coefficient $f_H=1$ for hardness of bush is 58HRC or more
- f_T : temperature coefficient $f_T=1$ operating temperature is below 100°C (80°C is maximum for Bush with resin retainer)
- f_C : contact coefficient $f_C=1$ for bushes are not in close contact
- f_W : applied load coefficient $f_W=1.5$ for $V_{max}=150\text{mm/s}$

◎ Calculating Rated Life

Selecting Bush 1 that carries the maximum equivalent load

$$L = \left(\frac{f_H \times f_T \times f_C}{f_W} \times \frac{C}{P_m} \right)^3 \times 50$$

$$L = \left(\frac{1 \times 1 \times 1}{1.5} \times \frac{2490}{505.0} \right)^3 \times 50 = 1775(\text{km})$$

◎ Calculating Life Time

$$L_h = \frac{L \times 10^3}{2 \times l_s \times n_1 \times 60}$$

$$L_h = \frac{1775 \times 10^3}{2 \times 0.120 \times 33 \times 60} = 3735(\text{hour})$$

⑤ Calculating Static Safety Factor

◎ Equation for Static Equivalent Load

$$P_0 = P_r + P_s$$

$P_{0a1} = P_{ra1} + P_{sa1} = 393.3 + 187.3 = 580.6(\text{N})$
calculating in the same manner

Table 1-34

	acceleration	constant	deceleration
bush 1	$P_{0a1} = 580.6$	$P_{01} = 503.5$	$P_{0d1} = 426.5$
bush 2	$P_{0a2} = 580.6$	$P_{02} = 503.5$	$P_{0d2} = 426.5$

Selecting Bush 1 that carries the maximum static equivalent load

$$f_s = \frac{C_0}{P_0}$$

$$f_s = \frac{C_0}{P_{0a1}} = \frac{5490}{580.6} = 9.4$$

RIGIDITY AND PRELOAD

Effect of Preload and Rigidity

The rigidity of a linear system must be taken into consideration when it is to be used in high-precision positioning devices or high-precision machinery. Preloaded slide guides and ball splines, which use balls as the rolling elements, are available upon request to meet the need for greater rigidity.

If a force is applied to the ball elements without preload, an elastic deformation proportional to the applied force to the 2/3 power will result. Therefore, the elastic deformation is relatively large during the initial loading stage, however then becomes smaller as the load increases.

Preloading on the rolling elements absorbs the deformation of the block under the same loading. Please contact NB for available data in regard to rigidity.

Types of Preload and its Specification

Preload is categorized into three ranges: standard, light, and medium for option. In the NB linear system, preload is applied by installing rolling elements that are slightly larger than standard. Therefore, the specification of the preload is expressed by a negative value.

Figure 1-16 Applied Load versus Block Deformation

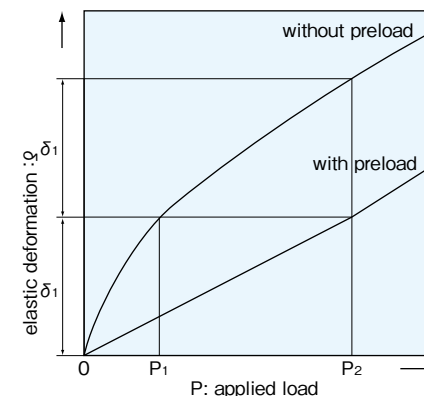

FRICIONAL RESISTANCE AND REQUIRED THRUST

The static friction of a linear system is extremely low. Since the difference between the static and dynamic friction is marginal, stable motion can be achieved from low to high speed. The frictional resistance (required thrust) can be obtained from the load and the seal resistance unique to each type of system using the following equation:

$$F = \mu \cdot W + f \quad \dots\dots\dots (14)$$

F: frictional resistance (N) μ : dynamic friction coefficient
W: applied load (N) f: seal resistance (N)

The dynamic friction coefficient varies with the applied load, preload, viscosity of the lubricant, and other factors. However, the values given in Table 1-35 are used for the normal loading condition (20% of basic dynamic load rating) without any preload. The seal resistance depends on the seal-lip condition as well as on the condition of the lubricant, however, it does not change proportionally with the applied load, which commonly is expressed by a constant value of 2 to 5 N.

Table 1-35 Dynamic Friction Coefficient

product	type	dynamic friction coefficient (μ)	
Slide Guide	SGL·SGW	0.002~0.003	
	SEB	0.004~0.006	
	SER	0.004~0.006	
Ball Spline	SSP	0.004~0.006	
Rotary Ball Spline	SPR·SPB SPBR	0.004~0.006	
Stroke Ball Spline	SPLFS	0.001~0.003	
Slide Bush	SM·KB SW·GM SMA·SME	0.002~0.003	
	Top Ball	TK·TKA TKE·TKD TW·TWA TWJ·TWD	0.002~0.003
		Stroke Bush	SR
Slide Rotary Bush		SRE	0.002~0.003
		RK	0.002~0.003
Slide Way	NV·SV·RV	0.001~0.003	
Slide Table	NVT·NYT·SVT·SYT	0.001~0.003	
Miniature Slide	SYBS	0.001~0.003	

Figure 1-17 Applied Load versus Dynamic Friction Coefficient

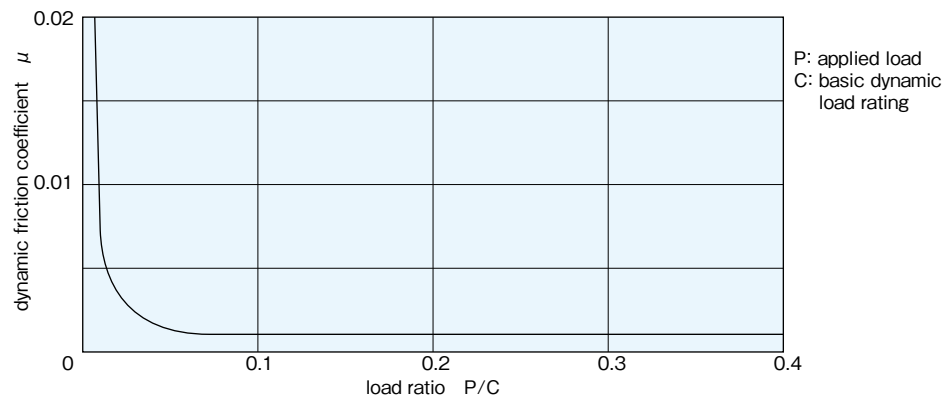

OPERATING ENVIRONMENT

Temperature Range

The NB linear systems are heat-treated in order to harden the surface. Therefore, if the temperature of the linear system exceeds 100°C, the hardness and load rating will be reduced (refer to page Eng-5, hardness coefficient). If resin is used in any one of the components, the system cannot be used in a high-temperature environment. The recommended operating temperature ranges for each type of linear system are listed in Table 1-36.

Table 1-36 Major Types and Recommended Temperature Range

component material	includes resin	steel	stainless	other
operating temperature range	-20°C~80°C	-20°C~110°C	-20°C~140°C*	
Slide Guide	SEB-A/SEBS-B SGL/SGW	SER	SEBS-BM SERS	
Ball Spline	SSP/SSPF/SPBF		SPLFS	
Rotary Ball Spline	SPR/SPB/SPBR			
Slide Bush	SM G/KB G/ SW G/SMS G/ KBS G/SWS G/GM SMA G/SMSA/ AK G/RBW/CE/CD	SM/KB/SW SMA/AK	SMS/KBS/SWS AKS	
Top Ball	TK/TKA TKE/TKD TW/TWA TWJ/TWD			
Stroke Bush		SR/SRB		
Slide Rotary Bush	RK	SRE		
Slide Way	NV/NVS	SV/RV	SVS/NVS-RNS	
Slide Table	NVT/NYT	SVT/SYT	SYTS	SVTS**
Miniature Slide			SYBS	
Slide Screw		SS		

* If the system is made of stainless steel and has a seal, the temperature range is up to 120°C
** Please contact NB if the system is to be used out of room temperatures.

Temperature Conversion Equation:

$$C = \frac{5}{9}(F - 32) \quad F = \frac{9}{5}C + 32$$

Operating Environment

Foreign particles or dust in the linear system affects the motion accuracy and shortens the life time. Standard seals will perform well for dust prevention under normal operating conditions, however, in a harsh environment it is necessary to attach bellows or protective covers as Figure 1-18 shows.

Figure 1-18 Example of Dust Prevention

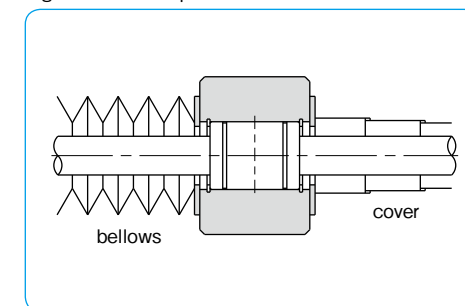

LUBRICATION

The objective of lubrication includes the reduction of friction among the rolling elements as well as between the rolling elements and the raceway, prevention of sintering, reduction of wear, and the prevention of rust by forming a film over the surfaces. To maximize the performance of a linear system, the lubricant type and a lubrication method appropriate for the operating environment should be selected.

There are two types of lubrication; oil lubrication and grease lubrication. For oil lubrication, turbine oil conforming to ISO standard VG32 to 68 is recommended.

For grease lubrication, lithium soap based grease No.2 is recommended. For slide bush and some other products, anti-rust oil that does not adversely affect the lubricant is applied prior to shipment. Please apply lubricant before using these products. (see Table 1-37) Products with raceway grooves, such as slide guide, are delivered pre-lubricated with grease for immediate use. Please relubricate with a similar type of grease periodically depending on the operating conditions. The recommended relubrication period is about 6 months or 1,000km of travel distance under normal conditions.

Table 1-37 Grease and Anti-rust oil

type	grease application
Slide Guide	grease pre-applied
Ball Spline	grease pre-applied
Rotary Ball Spline	grease pre-applied
Slide Bush	anti-rust oil only
Stroke Bush	anti-rust oil only
Slide Rotary Bush	anti-rust oil only
Slide Way	grease pre-applied
Slide Table	grease pre-applied
Miniature Slide	grease pre-applied

NB provides the following optional greases. Please select one in accordance with the use conditions of your linear system.

●KGL Grease (Low Dust Generation Grease)

KGL Grease has an excellent property of low dust generation with a lithium-type thickening agent used. It is ideal for use in a clean room.

●KGU Grease (Low Dust Generation Grease)

With urea-type thickening agent used, KGU Grease has features including a superior low dust generation property and the reduced dynamic frictional resistance during low-speed operation.

Table 1-38 Main Property

item	grease name	
	KGL Grease	KGU Grease
appearance	light yellowish-white	light brown
base oil	synthetic oil and refined oil mixed	synthetic oil and refined oil mixed
kinematic viscosity of base oil (mm ² /s, 40°C)	32	100
thickening agent	lithium soap	urea
mixture viscosity	237	248
drop point (°C)	201	280 or higher
copper plate corrosion (100°C, 24hrs)	passed	passed
evaporation (mass%)	0.8 (99°C 22h)	0.61 (150°C 22h)
oil separation (mass%:100°C, 24hrs)	0.9	0.5
oxidation stability (MPa99°C, 100hrs)	0.04	0.015
bearing corrosion prevention (52°C, 48hrs)	passed	passed
operating temperature range (°C)	-20~120	-30~160

Figure 1-19 Dust Level Measurement Data

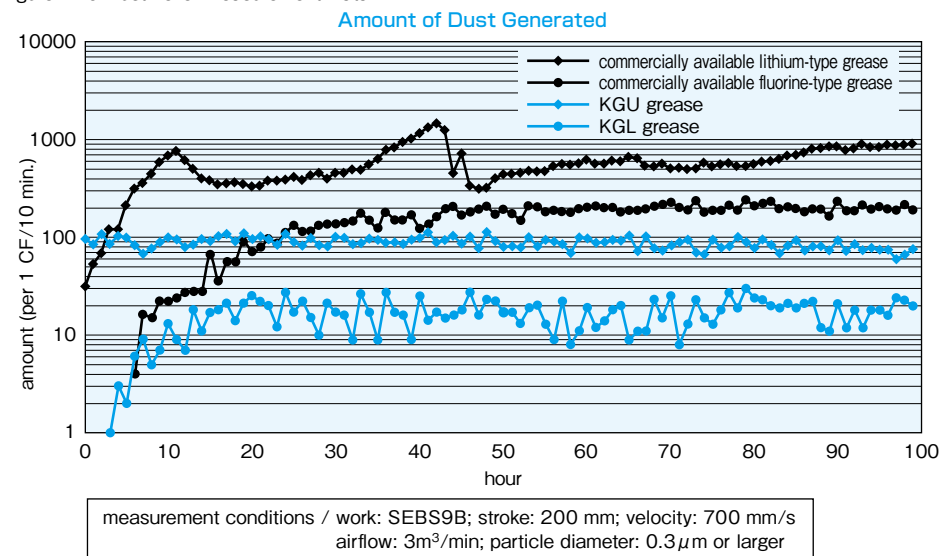
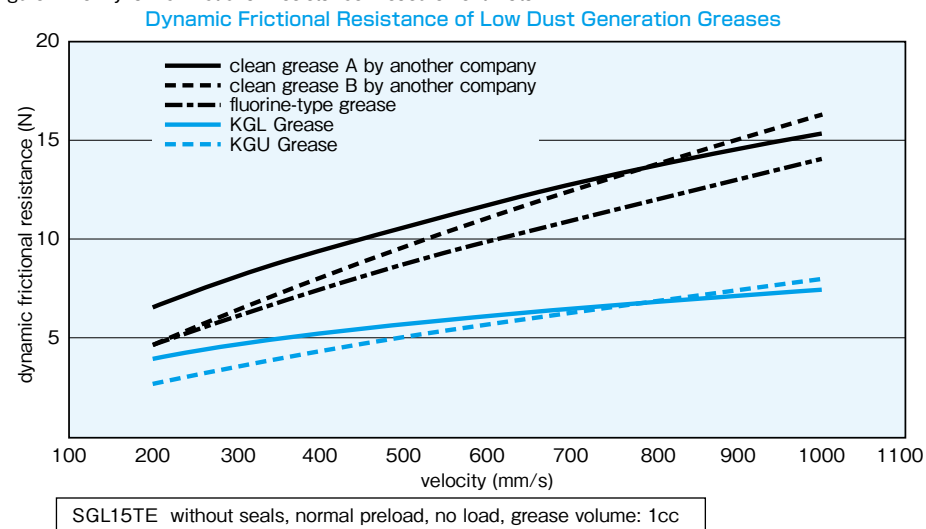

Figure 1-20 Dynamic Frictional Resistance Measurement Data



●KGF Grease (Anti-fretting/Anti-corrosion Grease)

With urea-type thickening agent used, KGF Grease is very effective to prevent fretting and corrosion.

Table 1-39 Main Property

item	grease name KGF Grease
appearance	brown
base oil	synthetic oil
kinematic viscosity of base oil (mm ² /s, 40°C)	approx. 25
thickening agent	urea
mixture viscosity	292
drop point (°C)	250 or higher
copper plate corrosion (100°C, 24 hrs)	passed
evaporation (mass%)	0.27 (99°C 22h)
oil separation (mass%100°C, 24 hrs)	1.1
oxidation stability (MPa99°C, 100 hrs)	0.085
bearing corrosion prevention (52°C, 48 hrs)	passed
rinsing water resistance (38°C, 1 hr)	1.7
operating temperature range (°C)	-20~150

Anti-fretting/Anti-corrosion Test Data

Table 1-40 Test Conditions

item	content
tested item	NVT4165
stroke	2 mm
acceleration	2.4G
average acceleration	0.1 m/s
cycle per minute	1,450 cpm
grease injection volume	0.5 cc
total travel distance	184 km
total cycles	46 million cycles

●Grease for the food processing industry (NSF H1 certified) is available.

It is the most suitable combination for the food processing applications to use this type of grease with stainless steel products. Please contact NB for details.

Figure 1-21 Raceway Condition after Testing

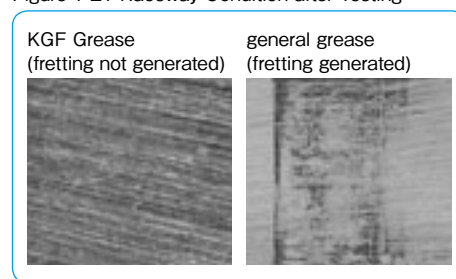

NB MAINTENANCE KIT

There are two types of maintenance kit available at NB.

1. Grease Gun Set: GG1

Different types of nozzles are adaptable to a variety of products including Actuators and products with grease-fitting.

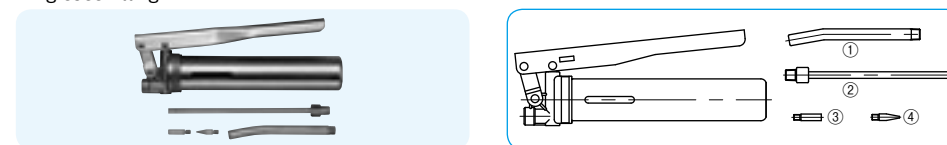

- ① Lubricant Nozzle (φ10)
Slide Guide SGL, SGW (except #17)
Actuator BG (#46 or larger)
Slide Bush SM, TR
- ②+Lubricant Nozzle ③(φ5)
Slide Guide SGW (#17 only)
Actuator BG (#33 or smaller)
Others
- ②+Lubricant Nozzle ④
Ball Screw
Products with Oil Hole

In the case of difficulty in pumping, due to internal grease adhesion or shape of the bearing, please use nozzle ④ to apply grease directly onto running grooves.

2. Grease Dispenser: TUI

Syringe dispenser is recommended for miniature guide (SEBS-B type) and for limited space applications.

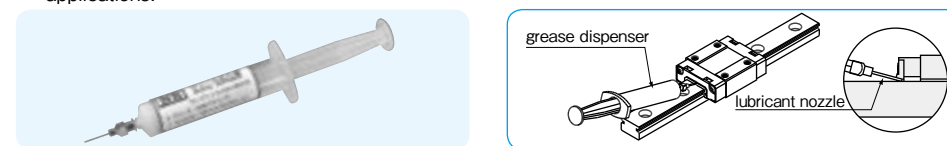

- ① Lubricant Nozzle (19G)
Needle Diameter : φ1.00
Needle Inner Diameter : φ0.67 (for KGF Grease)
- ② Lubricant Nozzle (17G)
Needle Diameter : φ1.50
Needle Inner Diameter : φ1.03 (for KGL·KGU Grease)

PRECAUTIONS FOR HANDLING AND USE

Please follow the instructions below to maintain the accuracy of NB linear system as a precision part and for a safety use.

- ⚠ (1) Notes on Handling
 - ① Any shock load caused by rough handling (such as dropping or hitting with hammer) may cause a scar or dent on the raceway which will hinder smooth movement and shorten expected travel life. Also be aware that such impact may damage the resin parts.
 - ② Never try to disassemble the product. Doing so may cause an entry of contamination or deterioration of assembly accuracy.
 - ③ The blocks or the outer cylinders may move just by tilting the rail or the shaft. Be careful not to let them fall off from the rail or the shaft by mistake.
 - ④ The accuracy on the mounting surface and parallelism of the rails or the shafts after assembly are important factors to optimize the performance of the linear system. Exercise adequate care for mounting accuracy.
- ⚠ (2) Notes on Use
 - ① Be careful not to let dust or foreign particles enter the linear system during use.
 - ② When using the linear system under an environment where dust or coolant may scatter, protect the system with a cover or bellows.
 - ③ When the NB linear system is used in a manner that its rail is fixed to the ceiling and downward load is applied to the block (s) or the outer cylinder (s), if the block or the outer cylinder breaks, it may fall off from the rail and drop to the floor. Provide additional measures for preventing dropping of the block or the outer cylinder, such as a safety catch.
- ⚠ (3) Instructions in considering the "Life Time" of a Linear System
 - ① When the load applied to a block or an outer cylinder exceeds 0.5 time of the basic dynamic load rating (P > 0.5C), the actual life of the system may become shorter than a calculated life time. Therefore, it is recommended to use the system with 0.5C or lower.
 - ② In the repetition of very minute stroke, where the rolling element, a steel ball or a cylindrical roller, makes only less than a half turn, early wear called fretting occurs at the contact points between the rolling elements and the raceway. There is no perfect measure to avoid this, but the life of the system can be extended by using anti-fretting grease and moving the blocks or the outer cylinders for the full stroke length once in a few thousand times of use.
Anti-fretting grease is available as an option. Please select it for applications with very minute stroke length.